

LUCETTE

PRICE BOOK



CENTURY

BATHWORKS

973-785-4290 • 800-524-2578 • FAX 973-785-0777

INDEX 2

SUMMARY 3

LUCETTE TUB AND STALLS (BYPASS) 4 - 6

LUCETTE BYPASS CORNERS 7 - 8

PIVOT HINGE 9 - 10

PIANO HINGE 11 - 16

PIANO HINGE FRENCH DOORS 17

PIANO HINGE CORNER ENCLOSURE 18 - 19

PIANO HINGE NEO ANGLE 20

STATIONARY PANEL 21

STEAM OPTIONS 22

GLASS UPGRADES/GRIDS 23 - 24

DECORATIVE FINISHES 25

CUSTOM GLASS FABRICATION 26

HANDLES 27

TOWEL BARS 29

FILLERS 28

FRAMED SLIDERS	
L-1XX	Tub Enclosure
L-XXXX	Stall Enclosure
L-636-X	Tub Enclosure w/ 90° return
L-1648-X/1660-X	Stall Enclosure w/ 90° return
L-668	Neo-Angle Corner Tub Enclosure
L-1689	Custom Angle Ceiling Bypass

STATIONARY PANELS	
L-100-XX	Stationary Spray Panels
L-101-XX	
L-102-XX	

FRAMED HINGE ENCLOSURES

Hinge/Mount Type:	Pivot (P-)	Piano Hinge (L-)	BiFold (L-)
CONFIGURATIONS			
64	X	X	
70	X	X	
71		X	
1627		X	
1628		X	
1629		X	
1630		X	
1669/1669-B		X	
1669 2/3		X	
1631		X	

The table above is meant to display all available Lucette hinge door models. An “X” indicates that the configuration is available for the corresponding hinge type. The following pages include pricing for the majority of models, though some have been excluded to simplify the book. Please contact us if you would like pricing for any enclosure that is not included in the book- we would be happy to help.

LUCETTE BYPASS

Standard Features:

- Flat header standard—round or crown molding available at additional charge. • Easy to clean bottom track
- Pricing shown assumes 5/32" tempered glass • Standard finish is silver anodized aluminum, but other finishes are available
- Single towel bar & brackets standard, mounted to frame
- Vinyl wall seals eliminate the need for caulking
- Adjustable rollers with ball bearings and nylon tires
- Fillers are available for out of plumb and out of level conditions, where the outage is greater than 3/16". See page 28 for details.
- Custom configurations are available for most bypass units, including additional inline panels, buttress panels, angle cut panels or doors to follow the slope of the ceiling, etc. Please contact us for details.

Available in Standard Paint

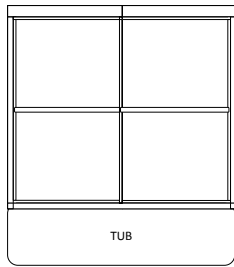

BYPASS TUB							
	MODEL	OPENING WIDTH	HEIGHT	SILVER	GOLD	SATIN NICKEL	STANDARD PAINT
CLEAR 5/32"	L-144	44-45"	58 1/8"	\$857	\$954	\$1,064	\$1,323
	↓	↓					
	L-150	50-51"		\$766	\$861	\$973	\$1,232
	L-151	51-52"					
	↓	↓		\$895	\$989	\$1,099	\$1,360
	L-158	58-59"					
	*L-158E	58-59"		\$967	\$1,065	\$1,174	\$1,433
	L-162	62-63"					
	L-163	63-64"		\$1,044	\$1,141	\$1,249	\$1,508
	L-164	64-65"					
	L-167	67-68"		\$721	\$819	\$927	\$1,186
	L-168	68-69"					
	L-170	70-71"		\$748	\$845	\$954	\$1,213
	L151-56	50 1/4- 51 1/4"					
L153-56	53 1/2- 54 1/2"	\$760	\$856	\$964	\$1,224		
L156-56	55- 56 1/4"						
L154-55	54-55"	\$744	\$842	\$951	\$1,211		
SPRAYLITE 5/32"	L-144	44-45"	58 1/8"	\$886	\$982	\$1,092	\$1,351
	↓	↓					
	L-150	50-51"		\$790	\$885	\$994	\$1,254
	L-151	51-52"					
	↓	↓		\$919	\$1,014	\$1,123	\$1,383
	L-158	58-59"					
	L-162	62-63"		\$1,000	\$1,095	\$1,206	\$1,467
	L-163	63-64"					
	L-164	64-65"		\$741	\$837	\$948	\$1,207
	L-167	67-68"					
	L-168	68-69"		\$768	\$865	\$975	\$1,234
	L-170	70-71"					
	L151-56	50 1/4- 51 1/4"		\$782	\$877	\$986	\$1,246
	L153-56	53 1/2- 54 1/2"					
L156-56	55- 56 1/4"	\$767	\$862	\$974	\$1,233		
L154-55	54-55"						

Anodized aluminum may vary in shade and color among extrusions. Color variance is considered within factory tolerances in the Anodizing Industry.

Available in Standard Paint

MODULE STALL BYPASS								
	MODEL	OPENING WIDTH	HEIGHT	SILVER	GOLD	SATIN NICKEL	STANDARD PAINT	
CLEAR 5/32"	L-3966	39"-40"	66 1/8"	\$765	\$859	\$968	\$1,230	
	↓	↓						
	L-4666	46-47"		68 1/8"	\$818	\$912	\$1,020	\$1,281
	L-4766	47-48"						
	↓	↓						
	L-5366	53-54"			\$871	\$966	\$1,077	\$1,337
	L-5466	54-55"						
	↓	↓						
	L-5866	58-59"						
	L4068	39"-40"						
	L4268	41 1/2-42 1/2"		\$750	\$846	\$954	\$1,213	
	L4468	43 1/2- 44 1/2"						
SPRAYLITE 5/32"	L-3966	39"-40"	66 1/8"	\$787	\$882	\$990	\$1,252	
	↓	↓						
	L-4666	46-47"		68 1/8"	\$842	\$937	\$1,046	\$1,306
	L-4766	47-48"						
	↓	↓						
	L-5366	53-54"			\$900	\$995	\$1,105	\$1,365
	L-5466	54-55"						
	↓	↓						
	L-5866	58-59"						
	L4068	39"-40"						
	L4268	41 1/2-42 1/2"		\$770	\$867	\$976	\$1,235	
	L4468	43 1/2- 44 1/2"						

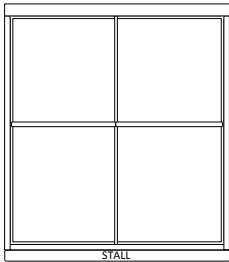

Anodized aluminum may vary in shade and color among extrusions. Color variance is considered within factory tolerances in the Anodizing Industry.

Available in Standard Paint

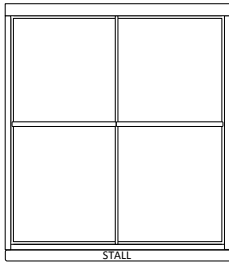

STALL BYPASS							
	MODEL	OPENING WIDTH	HEIGHT	SILVER	GOLD	SATIN NICKEL	STANDARD PAINT
CLEAR 5/32"	L-3970	39"-40"	70 7/8"	\$783	\$878	\$987	\$1,247
	↓	↓					
	L-4670	46-47"					
	L-4770	47-48"					
	↓	↓		\$870	\$965	\$1,076	\$1,336
	L-5370	53-54"					
	L-5470	54-55"					
	↓	↓					
	L-5870	58-59"	\$909	\$1,019	\$1,116	\$1,374	
	L4072	39"-40"					
	L4672	46- 47"					
	L5872	58- 59"					
SPRAYLITE 5/32"	L-3970	39"-40"	70 7/8"	\$854	\$975	\$1,011	\$1,271
	↓	↓					
	L-4670	46-47"					
	L-4770	47-48"					
	↓	↓		\$897	\$1,066	\$1,103	\$1,363
	L-5370	53-54"					
	L-5470	54-55"					
	↓	↓					
	L-5870	58-59"	\$940	\$1,110	\$1,147	\$1,406	
	L4072	39"-40"					
	L4672	46- 47"					
	L5872	58- 59"					
			72 1/8"	\$801	\$897	\$1,007	\$1,266
				\$842	\$937	\$1,046	\$1,306
				\$999	\$1,094	\$1,203	\$1,464
				\$815	\$941	\$1,019	\$1,279
				\$867	\$1,009	\$1,070	\$1,331
				\$1,015	\$1,136	\$1,221	\$1,480

Anodized aluminum may vary in shade and color among extrusions. Color variance is considered within factory tolerances in the Anodizing Industry.

Available in Standard Paint * Buttruss available

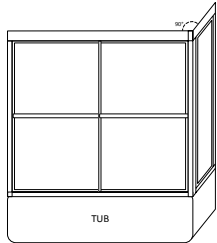

L-636 BYPASS TUB WITH 90° RETURN PANEL							
	MODEL	OPENING WIDTH (centerline dimensions)	HEIGHT	SILVER	GOLD	SATIN NICKEL	STANDARD PAINT
CLEAR 5/32"	L-636-1	52-59" w/ return up to 34"	58 1/8"	\$1,470	\$1,612	\$1,776	\$2,165
	L-636-2	52-59" w/ return up to 38"		\$1,537	\$1,680	\$1,845	\$2,236
	L-636-3	59-65" w/ return up to 34"		\$1,512	\$1,657	\$1,822	\$2,211
	L-636-4	59- 65" w/ return up to 38"		\$1,581	\$1,725	\$1,889	\$2,279
	L-636-5	67- 71" w/ return up to 34"		\$1,552	\$1,696	\$1,860	\$2,250
	L-636-6	67- 71" w/ return up to 38"		\$1,622	\$1,766	\$1,930	\$2,319
SPRAYLITE 5/32"	L-636-1	52-59" w/ return up to 34"	58 1/8"	\$1,617	\$1,764	\$1,933	\$2,334
	L-636-2	52-59" w/ return up to 38"		\$1,726	\$1,874	\$2,043	\$2,445
	L-636-3	59-65" w/ return up to 34"		\$1,676	\$1,825	\$1,993	\$2,397
	L-636-4	59- 65" w/ return up to 38"		\$1,784	\$1,932	\$2,102	\$2,504
	L-636-5	67- 71" w/ return up to 34"		\$1,729	\$1,877	\$2,046	\$2,448
	L-636-6	67- 71" w/ return up to 38"		\$1,839	\$1,986	\$2,155	\$2,556

Anodized aluminum may vary in shade and color among extrusions.
Color variance is considered within factory tolerances in the Anodizing Industry.

Available in Standard Paint * Buttress available

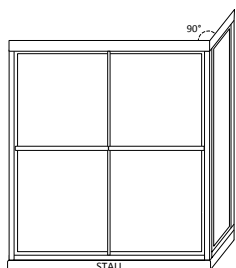

L-1648 & 1660 STALL BYPASS WITH 90° RETURN PANEL							
	MODEL	OPENING WIDTH (centerline dimensions)	HEIGHT	SILVER	GOLD	SATIN NICKEL	STANDARD PAINT
CLEAR 5/32"	L-1648-1	39-48" w/ return up to 30"	70 7/8"	\$1,414	\$1,559	\$1,722	\$2,112
	L-1648-2	39-48" w/ return up to 36"		\$1,487	\$1,631	\$1,795	\$2,184
	L-1660-3	48-59" w/ return up to 30"		\$1,488	\$1,632	\$1,796	\$2,186
	L-1660-4	48-59" w/ return up to 36"		\$1,561	\$1,704	\$1,867	\$2,258
SPRAYLITE 5/32"	L-1648-1	39-48" w/ return up to 30"	70 7/8"	\$1,636	\$1,792	\$1,970	\$2,391
	L-1648-2	39-48" w/ return up to 36"		\$1,744	\$1,899	\$2,076	\$2,498
	L-1660-3	48-59" w/ return up to 30"		\$1,719	\$1,873	\$2,052	\$2,476
	L-1660-4	48-59" w/ return up to 36"		\$1,827	\$1,982	\$2,159	\$2,581

Anodized aluminum may vary in shade and color among extrusions.
Color variance is considered within factory tolerances in the Anodizing Industry.

LUCETTE PIVOT HINGE

STANDARD FEATURES:

- Top & bottom pivot hinges, with no header
- Pricing shown assumes 5/32" tempered glass
- Standard finish is silver anodized aluminum, but other finishes are available
- Standard handle
- Pivot bar allows 1" up or down adjustment on width
- Fillers are available for out of plumb and out of level conditions, where the outage is greater than 3/16". See page 28 for details.

Available in Standard Paint

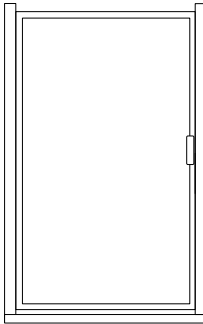

P-64 MODULE SINGLE DOOR							
	MODEL	OPENING WIDTH	HEIGHT	SILVER	GOLD	SATIN NICKEL	STANDARD PAINT
CLEAR 5/32"	P-64-22	21 3/4- 23 3/4"	65 3/4"	\$419	\$468	\$522	\$653
	P-64-23	22 3/4- 24 3/4"					
	P-64-24 1/4	23 1/4- 25 1/4"					
	P-64-24 3/4	23 3/4- 25 3/4"					
	P-64-25	24 3/4- 26 3/4"					
	P-64-27	26 3/4- 28 3/4"					
	P-64-29	28 3/4- 30 3/4"					
	P-64-31	30 3/4- 32 3/4"					
	P-64-33	32 1/4- 34 1/4"					
	P-64-35	34 1/4- 36 1/4"					
SPRAYLITE 5/32"	P-64-22	21 3/4- 23 3/4"	65 3/4"	\$482	\$480	\$534	\$663
	P-64-23	22 3/4- 24 3/4"					
	P-64-24 1/4	23 1/4- 25 1/4"					
	P-64-24 3/4	23 3/4- 25 3/4"					
	P-64-25	24 3/4- 26 3/4"					
	P-64-27	26 3/4- 28 3/4"					
	P-64-29	28 3/4- 30 3/4"					
	P-64-31	30 3/4- 32 3/4"					
	P-64-33	32 1/4- 34 1/4"					
	P-64-35	34 1/4- 36 1/4"					

Anodized aluminum may vary in shade and color among extrusions. Color variance is considered within factory tolerances in the Anodizing Industry.

Available in Standard Paint

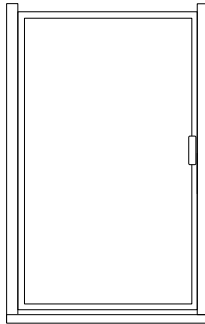

P-70 SINGLE DOOR							
	MODEL	OPENING WIDTH	HEIGHT	SILVER	GOLD	SATIN NICKEL	STANDARD PAINT
CLEAR 5/32"	P-70-22	21 3/4- 23 3/4"	70 1/2"	\$444	\$493	\$547	\$678
	P-70-23	22 3/4- 24 3/4"					
	P-70-25	24 3/4- 26 3/4"					
	P-70-27	26 3/4- 28 3/4"		\$471	\$520	\$574	\$704
	P-70-29	28 3/4- 30 3/4"					
	P-70-31	30 3/4- 32 3/4"					
	P-70-33	32 1/4- 34 1/4"					
P-70-35	34 1/4- 36 1/4"	\$519	\$566	\$622	\$751		
SPRAYLITE 5/32"	P-70-22	21 3/4- 23 3/4"	70 1/2"	\$456	\$503	\$559	\$689
	P-70-23	22 3/4- 24 3/4"					
	P-70-25	24 3/4- 26 3/4"					
	P-70-27	26 3/4- 28 3/4"		\$485	\$534	\$589	\$718
	P-70-29	28 3/4- 30 3/4"					
	P-70-31	30 3/4- 32 3/4"					
	P-70-33	32 1/4- 34 1/4"					
	P-70-35	34 1/4- 36 1/4"		\$535	\$583	\$637	\$767

Anodized aluminum may vary in shade and color among extrusions. Color variance is considered within factory tolerances in the Anodizing Industry.

LUCETTE PIANO HINGE

STANDARD FEATURES:

- Continuous piano hinge
- Round header standard- flat header available at no extra charge; crown molding header available at an additional charge
- Pricing shown assumes 5/32" tempered glass
- Standard finish is silver anodized aluminum, but other finishes are available
- Standard handle
- Can be made to be inswing
- Fillers are available for out of plumb and out of level conditions, where the outage is greater than 3/16". See page30 for details.
- Custom configurations are available for most units, including additional inline panels, buttress panels, angle cut panels or doors to follow the slope of the ceiling, etc. Please contact us for details.

Available in Standard Paint

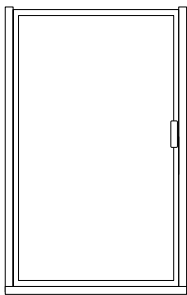

L-64 MODULE SINGLE DOOR (NO HEADER)										
	MODEL	OPENING WIDTH	HEIGHT	SILVER	GOLD	SATIN NICKEL	STANDARD PAINT			
CLEAR 5/32"	L-64-21 1/2	21 1/2"-22"	64 3/4"	\$460	\$507	\$563	\$692			
	↓	↓								
	L-64-26	26- 26 1/2"		\$483	\$531	\$585	\$715			
	L-64-26 1/2	26 1/2- 27"								
	↓	↓								
	L-64-29 1/2	29 1/2- 30"								
	L-64-30	30- 30 1/2"								
	↓	↓								
L-64-31 1/2	31 1/2- 32"	\$502	\$550	\$603	\$733					
↓	↓									
L-64-21 1/2	21 1/2"-22"					64 3/4"	\$469	\$517	\$572	\$702
↓	↓									
L-64-26	26- 26 1/2"						\$494	\$542	\$597	\$728
L-64-26 1/2	26 1/2- 27"									
↓	↓									
L-64-29 1/2	29 1/2- 30"									
L-64-30	30- 30 1/2"									
↓	↓									
L-64-31 1/2	31 1/2- 32"	\$515	\$563	\$618	\$747					
↓	↓									

Anodized aluminum may vary in shade and color among extrusions. Color variance is considered within factory tolerances in the Anodizing Industry.

Available in Standard Paint

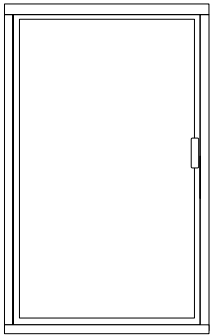

Anodized aluminum may vary in shade and color among extrusions. Color variance is considered within factory tolerances in the Anodizing Industry.

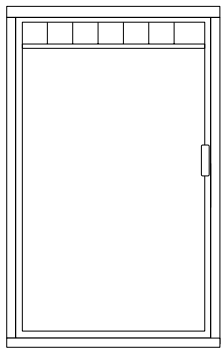

L-70- SINGLE DOOR							
	MODEL	OPENING WIDTH	HEIGHT	SILVER	GOLD	SATIN NICKEL	STANDARD PAINT
CLEAR 5/32"	L-70-20 1/2	20 1/2- 21"	71 1/4"	\$506	\$554	\$609	\$739
	↓	↓					
	L-70-24 1/2	24 1/2- 25"		\$531	\$578	\$633	\$763
	L-70-25	25- 25 1/2"					
	↓	↓		\$559	\$603	\$660	\$790
	L-70-28 1/2	28 1/2- 29"					
	L-70-29	29- 29 1/2"		\$609	\$620	\$673	\$802
	↓	↓					
L-70-32	32- 32 1/2"						
SPRAYLITE 5/32"	L-70-20 1/2	20 1/2- 21"	71 1/4"	\$530	\$564	\$620	\$748
	↓	↓					
	L-70-24 1/2	24 1/2- 25"		\$569	\$591	\$647	\$776
	L-70-25	25- 25 1/2"					
	↓	↓		\$609	\$620	\$673	\$802
	L-70-28 1/2	28 1/2- 29"					
	L-70-29	29- 29 1/2"					
	↓	↓					
L-70-32	32- 32 1/2"						

L-71- SINGLE DOOR W/ DECORATIVE GRILL							
	MODEL	OPENING WIDTH	HEIGHT	SILVER	GOLD	SATIN NICKEL	STANDARD PAINT
CLEAR 5/32"	L-71-21 1/2	21 1/2"-22"	71 1/4"	\$645	\$700	\$767	\$925
	↓	↓					
	L-71-26	26- 26 1/2"		\$674	\$729	\$797	\$954
	L-71-26 1/2	26 1/2- 27"					
	↓	↓		\$691	\$744	\$815	\$973
	L-71-29	29- 29 1/2"					
	L-71-29 1/2	29 1/2- 30"		\$706	\$760	\$829	\$986
	↓	↓					
L-71-31 1/2	31 1/2- 32"						
SPRAYLITE 5/32"	L-71-21 1/2	21 1/2"-22"	71 1/4"	\$656	\$712	\$780	\$937
	↓	↓					
	L-71-26	26- 26 1/2"		\$689	\$792	\$811	\$967
	L-71-26 1/2	26 1/2- 27"					
	↓	↓		\$706	\$760	\$829	\$986
	L-71-29	29- 29 1/2"					
	L-71-29 1/2	29 1/2- 30"					
	↓	↓					
L-71-31 1/2	31 1/2- 32"						

Available in Standard Paint * Butress available

LM-1627 MODULE DOOR & PANEL							
	MODEL	OPENING WIDTH	HEIGHT	SILVER	GOLD	SATIN NICKEL	STANDARD PAINT
CLEAR 5/32"	LM-1627-30	30-31"	65 5/8"	\$708	\$803	\$914	\$1,174
	↓	↓					
	LM-1627-35	35- 36"					
	LM-1627-36	36- 47"		\$741	\$837	\$948	\$1,207
	↓	↓					
	LM-1627-40	40- 41"					
	LM-1627-41	41- 42"		\$813	\$911	\$1,024	\$1,292
	↓	↓					
	LM-1627-47	47- 48"					
	LM-1627-48	48- 49"		\$829	\$925	\$1,034	\$1,293
	↓	↓					
	LM-1627-53	53- 54"					
	LM-1627-54	54- 55"		\$959	\$1,063	\$1,182	\$1,463
	↓	↓					
	LM-1627-59	59- 60"					
L-1627 KO	39 1/4- 40 1/4"	68 3/8"	\$760	\$857	\$965	\$1,225	
L-1627 MOD	43 1/4- 44 1/4"		\$795	\$890	\$1,000	\$1,260	
SPRAYLITE 5/32"	LM-1627-30	30-31"	65 5/8"	\$712	\$808	\$916	\$1,183
	↓	↓					
	LM-1627-35	35- 36"					
	LM-1627-36	36- 47"		\$813	\$917	\$1,034	\$1,312
	↓	↓					
	LM-1627-40	40- 41"					
	LM-1627-41	41- 42"		\$861	\$964	\$1,083	\$1,364
	↓	↓					
	LM-1627-47	47- 48"					
	LM-1627-48	48- 49"		\$917	\$1,019	\$1,139	\$1,421
	↓	↓					
	LM-1627-53	53- 54"					
	LM-1627-54	54- 55"		\$981	\$1,085	\$1,203	\$1,484
	↓	↓					
	LM-1627-59	59- 60"					
L-1627 KO	39 1/4- 40 1/4"	68 3/8"	\$841	\$942	\$1,055	\$1,323	
L-1627 MOD	43 1/4- 44 1/4"		\$883	\$985	\$1,104	\$1,386	

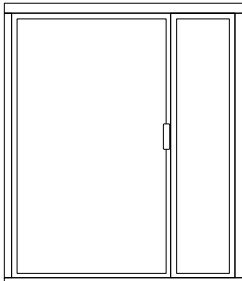

Anodized aluminum may vary in shade and color among extrusions. Color variance is considered within factory tolerances in the Anodizing Industry.

Available in Standard Paint

* Buttress available

L-1627 STALL DOOR & PANEL							
	MODEL	OPENING WIDTH	HEIGHT	SILVER	GOLD	SATIN NICKEL	STANDARD PAINT
CLEAR 5/32"	L-1627-30	30-31"	71 1/4"	\$717	\$812	\$922	\$1,182
	↓	↓					
	L-1627-35	35- 36"					
	L-1627-36	36- 47"		\$754	\$849	\$960	\$1,229
	↓	↓					
	L-1627-40	40- 41"					
	L-1627-41	41- 42"		\$862	\$966	\$1,082	\$1,349
	↓	↓					
	L-1627-47	47- 48"					
	L-1627-48	48- 49"		\$932	\$1,037	\$1,155	\$1,457
	↓	↓					
	L-1627-53	53- 54"					
	L-1627-54	54- 55"		\$1,023	\$1,125	\$1,243	\$1,526
↓	↓						
L-1627-59	59- 60"						
SPRAYLITE 5/32"	L-1627-30	30-31"	71 1/4"	\$758	\$858	\$970	\$1,239
	↓	↓					
	L-1627-35	35- 36"					
	L-1627-36	36- 47"		\$840	\$943	\$1,061	\$1,343
	↓	↓					
	L-1627-40	40- 41"					
	L-1627-41	41- 42"		\$888	\$992	\$1,111	\$1,391
	↓	↓					
	L-1627-47	47- 48"					
	L-1627-48	48- 49"		\$943	\$1,046	\$1,116	\$1,447
	↓	↓					
	L-1627-53	53- 54"					
	L-1627-54	54- 55"		\$1,033	\$1,136	\$1,255	\$1,537
↓	↓						
L-1627-59	59- 60"						

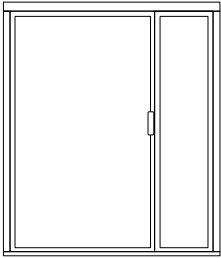

Anodized aluminum may vary in shade and color among extrusions. Color variance is considered within factory tolerances in the Anodizing Industry.

Available in Standard Paint

* Buttress available

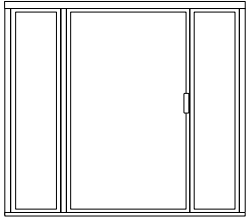

LM-1628 MODULE STALL PANEL, DOOR, PANEL							
	MODEL	OPENING WIDTH	HEIGHT	SILVER	GOLD	SATIN NICKEL	STANDARD PAINT
CLEAR 5/32"	LM-1628-28	28- 29"	65 5/8"	\$1,045	\$1,187	\$1,352	\$1,743
	↓	↓					
	LM-1628-40	40- 41"		\$1,034	\$1,177	\$1,342	\$1,730
	LM-1628-41	41- 42"					
	↓	↓		\$1,092	\$1,239	\$1,409	\$1,811
	LM-1628-47	47- 48"					
	LM-1628-48	48- 49"		\$1,187	\$1,336	\$1,506	\$1,908
	↓	↓					
	LM-1628-53	53- 54"		\$1,077	\$1,221	\$1,384	\$1,774
	LM-1628-54	54- 55"					
↓	↓	\$1,146	\$1,301	\$1,478	\$1,901		
LM-1628-59	59- 60"						
SPRAYLITE 5/32"	LM-1628-28	28- 29"	65 5/8"	\$1,193	\$1,348	\$1,526	\$1,947
	↓	↓					
	LM-1628-40	40- 41"		\$1,236	\$1,390	\$1,568	\$1,989
	LM-1628-41	41- 42"					
	↓	↓					
	LM-1628-47	47- 48"					
	LM-1628-48	48- 49"					
	↓	↓					
	LM-1628-53	53- 54"					
	LM-1628-54	54- 55"					
↓	↓						
LM-1628-59	59- 60"						

Anodized aluminum may vary in shade and color among extrusions. Color variance is considered within factory tolerances in the Anodizing Industry.

Available in Standard Paint

* Buttress available

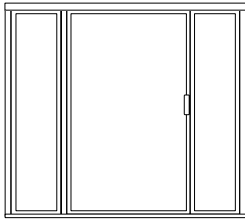

L-1628 STALL PANEL, DOOR, PANEL									
	MODEL	OPENING WIDTH	HEIGHT	SILVER	GOLD	SATIN NICKEL	STANDARD PAINT		
CLEAR 5/32"	L-1628-28	28- 29"	71 1/4"	\$967	\$1,113	\$1,277	\$1,666		
	↓	↓							
	L-1628-35	35- 36"		\$1,069	\$1,147	\$1,311	\$1,700		
	↓	↓							
	L-1628-41	41- 42"		\$1,070	\$1,187	\$1,387	\$1,790		
	↓	↓							
	L-1628-47	47- 48"		\$1,174	\$1,324	\$1,495	\$1,897		
	↓	↓							
	L-1628-53	53- 54"		\$1,213	\$1,368	\$1,547	\$1,968		
	↓	↓							
	L-1628-59	59- 60"							
	SPRAYLITE 5/32"	L-1628-30		30-31"	71 1/4"	\$987	\$1,131	\$1,294	\$1,685
		↓		↓					
		L-1628-36		36- 37"		\$1,074	\$1,222	\$1,391	\$1,792
↓		↓							
L-1628-41		41- 42"	\$1,156	\$1,311		\$1,489	\$1,912		
↓		↓							
L-1628-47		47- 48"	\$1,204	\$1,359		\$1,537	\$1,958		
↓		↓							
L-1628-53		53- 54"	\$1,246	\$1,401		\$1,579	\$2,001		
↓		↓							
L-1628-59		59- 60"							

Anodized aluminum may vary in shade and color among extrusions.
Color variance is considered within factory tolerances in the Anodizing Industry.

Available in Standard Paint

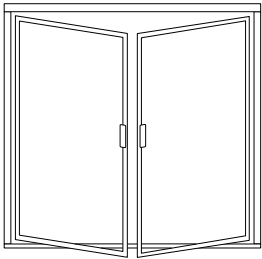

L-1629 FRENCH DOORS							
	MODEL	OPENING WIDTH	HEIGHT	SILVER	GOLD	SATIN NICKEL	STANDARD PAINT
CLEAR 5/32"	L-1629-32	32- 33"	71 1/4"	\$1,058	\$1,161	\$1,281	\$1,562
	↓	↓					
	L-1629-39	39- 40"		\$1,142	\$1,245	\$1,364	\$1,645
	L-1629-40	40- 41"					
	↓	↓		\$1,213	\$1,315	\$1,434	\$1,717
	L-1629-46	46- 47"					
	L-1629-47	47- 48"		\$1,279	\$1,382	\$1,499	\$1,781
	↓	↓					
	L-1629-53	53- 54"		\$1,098	\$1,203	\$1,322	\$1,602
	L-1629-54	54- 55"					
↓	↓	\$1,193	\$1,296	\$1,413	\$1,695		
L-1629-59	59- 60"						
SPRAYLITE 5/32"	L-1629-32	32- 33"	71 1/4"	\$1,272	\$1,376	\$1,493	\$1,776
	↓	↓					
	L-1629-39	39- 40"		\$1,344	\$1,449	\$1,567	\$1,847
	L-1629-40	40- 41"					
	↓	↓		\$1,272	\$1,376	\$1,493	\$1,776
	L-1629-46	46- 47"					
	L-1629-47	47- 48"		\$1,344	\$1,449	\$1,567	\$1,847
	↓	↓					
	L-1629-53	53- 54"		\$1,098	\$1,203	\$1,322	\$1,602
	L-1629-54	54- 55"					
↓	↓	\$1,193	\$1,296	\$1,413	\$1,695		
L-1629-59	59- 60"						

Anodized aluminum may vary in shade and color among extrusions. Color variance is considered within factory tolerances in the Anodizing Industry.

*MUST SPECIFY SHOWER HEAD LOCATION AND WHICH DOOR OPENS FIRST. ADA compliant

Available in Standard Paint * Buttress available

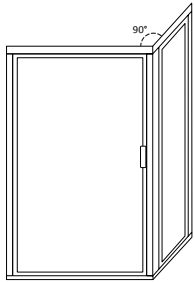

L-1630 DOOR WITH 90° RETURN PANEL							
	MODEL	OPENING WIDTH	HEIGHT	SILVER	GOLD	SATIN NICKEL	STANDARD PAINT
CLEAR 5/32"	L-1630	Centerline up to 30" x 34 1/2"	71 1/4"	\$1,209	\$1,311	\$1,429	\$1,712
	L-1630 NS1	Centerline up to 30" x 36"		\$1,235	\$1,337	\$1,454	\$1,738
	L-1630 NS2	Centerline up to 30" x 40"		\$1,285	\$1,390	\$1,509	\$1,790
	L-1630 NS3	Centerline up to 30" x 48"		\$1,393	\$1,497	\$1,616	\$1,897
SPRAYLITE 5/82"	L-1630	Centerline up to 30" x 34 1/2"	71 1/4"	\$1,344	\$1,449	\$1,567	\$1,847
	L-1630 NS1	Centerline up to 30" x 36"		\$1,381	\$1,484	\$1,602	\$1,884
	L-1630 NS2	Centerline up to 30" x 40"		\$1,453	\$1,559	\$1,677	\$1,957
	L-1630 NS3	Centerline up to 30" x 48"		\$1,601	\$1,705	\$1,823	\$2,103

Anodized aluminum may vary in shade and color among extrusions. Color variance is considered within factory tolerances in the Anodizing Industry.

Available in Standard Paint * Buttress available

L-1631 DOOR & PANEL WITH 90° RETURN PANEL

	MODEL	OPENING WIDTH (centerline dimensions)	HEIGHT	SILVER	GOLD	SATIN NICKEL	STANDARD PAINT
CLEAR 5/32"	L-1631 NS1	Centerline up to 34 1/2 x 34 1/2"	71 1/4"	\$1,420	\$1,574	\$1,751	\$2,172
	L-1631 NS2	Centerline up to 40 1/2 x 34 1/2"		\$1,443	\$1,599	\$1,777	\$2,199
	L-1631 NS3	Centerline up to 40 1/2 x 40 1/2"		\$1,520	\$1,677	\$1,855	\$2,275
	L-1631 NS4	Centerline up to 48" x 36"		\$1,504	\$1,658	\$1,835	\$2,256
	L-1631 NS5	Centerline up to 48" x 48"		\$1,655	\$1,809	\$1,988	\$2,411
	L-1631 NS6	Centerline up to 54" x 36"		\$1,530	\$1,686	\$1,862	\$2,285
	L-1631 NS7	Centerline up to 54" x 48"		\$1,681	\$1,836	\$2,015	\$2,437
	L-1631 NS8	Centerline up to 60" x 36"		\$1,560	\$1,716	\$1,892	\$2,314
	L-1631 NS9	Centerline up to 60" x 48"		\$1,707	\$1,862	\$2,040	\$2,463
SPRAYLITE 5/32"	L-1631 NS1	Centerline up to 34 1/2 x 34 1/2"	71 1/4"	\$1,535	\$1,689	\$1,867	\$2,288
	L-1631 NS2	Centerline up to 40 1/2 x 34 1/2"		\$1,562	\$1,718	\$1,894	\$2,316
	L-1631 NS3	Centerline up to 40 1/2 x 40 1/2"		\$1,665	\$1,822	\$1,999	\$2,421
	L-1631 NS4	Centerline up to 48" x 36"		\$1,632	\$1,786	\$1,964	\$2,387
	L-1631 NS5	Centerline up to 48" x 48"		\$1,839	\$1,994	\$2,171	\$2,595
	L-1631 NS6	Centerline up to 54" x 36"		\$1,660	\$1,815	\$1,992	\$2,415
	L-1631 NS7	Centerline up to 54" x 48"		\$1,867	\$2,021	\$2,200	\$2,623
	L-1631 NS8	Centerline up to 60" x 36"		\$1,687	\$1,842	\$2,019	\$2,440
	L-1631 NS9	Centerline up to 60" x 48"		\$1,894	\$2,050	\$2,228	\$2,650

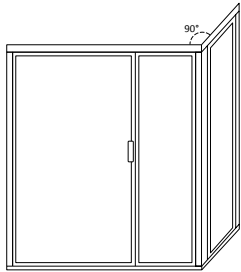

Anodized aluminum may vary in shade and color among extrusions.
Color variance is considered within factory tolerances in the Anodizing Industry.

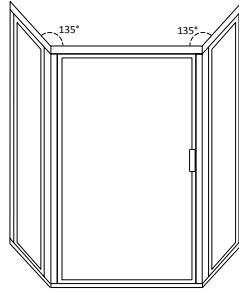

Available in Standard Paint

* Buttress available

L-1669 NEO-ANGLE PANEL, DOOR, PANEL

	MODEL	OPENING WIDTH (centerline dimensions)	HEIGHT	SILVER	GOLD	SATIN NICKEL	STANDARD PAINT
CLEAR 5/32"	L-1669 S-1	16 1/2" x 24 1/4" x 16 1/2" (Fits 36"x 36" Base)	71 1/4"	\$1,242	\$1,398	\$1,575	\$1,997
	L-1669 S-2	16 1/2" x 25 1/4" x 16 1/2" (Fits 36"x 36" Base)					
	L-1669 S-3	17 1/2" x 24 1/4" x 17 1/2" (Fits 38"x 38" Base)					
	L-1669 S-4	18 1/2" x 24 1/4" x 18 1/2" (Fits 38"x 38" Base)					
	L-1669 NS1	Centerline up to 18 1/2" x 24 1/4" x 18 1/2"		\$1,398	\$1,552	\$1,730	\$2,154
	L-1669 NS2	Centerline up to 22 1/2" x 26 1/4" x 22 1/2"		\$1,513	\$1,667	\$1,846	\$2,268
	L-1669 NS3	Centerline up to 30 1/2" x 28 1/4" x 30 1/2"		\$1,718	\$1,872	\$2,050	\$2,472
	L-1669 NS4	Centerline up to 36" x 30" x 36"		\$1,852	\$2,008	\$2,186	\$2,607
	L-1669 NS 2/3	Two Thirds of a 135° Neo Angle CLine up to 18 1/2" x 24 1/4"		\$1,030	\$1,185	\$1,364	\$1,785
	L-1669 LA	17 1/2" x 22 1/2" x 17 1/2"		65 5/8"	\$1,285	\$1,442	\$1,620
L-1669 LA2P	17 1/2" x 23 7/8" x 17 1/2"						
SPRAYLITE 5/32"	L-1669 S-1	16 1/2" x 24 1/4" x 16 1/2" (Fits 36"x 36" Base)	71 1/4"	\$1,263	\$1,420	\$1,595	\$2,018
	L-1669 S-2	16 1/2" x 25 1/4" x 16 1/2" (Fits 36"x 36" Base)					
	L-1669 S-3	17 1/2" x 24 1/4" x 17 1/2" (Fits 38"x 38" Base)					
	L-1669 S-4	18 1/2" x 24 1/4" x 18 1/2" (Fits 38"x 38" Base)					
	L-1669 NS1	Centerline up to 18 1/2" x 24 1/4" x 18 1/2"		\$1,677	\$1,831	\$2,010	\$2,431
	L-1669 NS2	Centerline up to 22 1/2" x 26 1/4" x 22 1/2"		\$1,844	\$1,999	\$2,177	\$2,598
	L-1669 NS3	Centerline up to 30 1/2" x 28 1/4" x 30 1/2"		\$2,125	\$2,280	\$2,457	\$2,879
	L-1669 NS4	Centerline up to 36" x 30" x 36"		\$2,290	\$2,449	\$2,625	\$3,047
	L-1669 NS 2/3	Two Thirds of a 135° Neo Angle CLine up to 18 1/2" x 24 1/4"		\$1,264	\$1,421	\$1,598	\$2,019
	L-1669 LA	17 1/2" x 22 1/2" x 17 1/2"		65 5/8"	\$1,385	\$1,539	\$1,718
L-1669 LA2P	17 1/2" x 23 7/8" x 17 1/2"						

Anodized aluminum may vary in shade and color among extrusions.
Color variance is considered within factory tolerances in the Anodizing Industry.

Available in Standard Paint

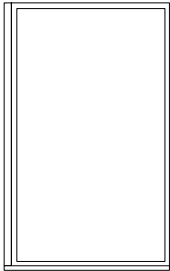

L-100, (L-101, L-102) STATIONARY PANEL							
	MODEL	OPENING WIDTH	HEIGHT	SILVER	GOLD	SATIN NICKEL	STANDARD PAINT
CLEAR 5/32"	L-100-30	18 1/2- 30"	Up to	\$404	\$454	\$507	\$637
	L-100-36	CUSTOM: 30- 36"	55 3/4"	\$601	\$651	\$708	\$841
	L101-30	19 1/2- 30"	Up to	\$446	\$496	\$552	\$687
	L-101-36	CUSTOM: 30- 36"	68 1/2"	\$725	\$775	\$831	\$936
	L-102-30	CUSTOM: Up to 30"	Up to 80"	\$821	\$869	\$924	\$1,054
	L-102-36	CUSTOM: Up to 36"		\$886	\$935	\$988	\$1,118
SPRAYLITE 5/32"	L-100-30	18 1/2- 30"	Up to	\$447	\$499	\$559	\$700
	L-100-36	CUSTOM: 30- 36"	55 3/4"	\$716	\$769	\$828	\$969
	L101-30	19 1/2- 30"	Up to	\$508	\$560	\$620	\$760
	L-101-36	CUSTOM: 30- 36"	68 1/2"	\$852	\$904	\$963	\$1,103
	L-102-30	CUSTOM: Up to 30"	Up to 80"	\$966	\$1,016	\$1,076	\$1,217
	L-102-36	CUSTOM: Up to 36"		\$1,103	\$1,155	\$1,214	\$1,356

Anodized aluminum may vary in shade and color among extrusions.
Color variance is considered within factory tolerances in the Anodizing Industry.

*Must specify 1,2,3, or 4 sided mount"

STEAM UNITS MADE WITHOUT A TRANSOM STEAM KIT

A steam efficient door can be accomplished by building the enclosure to full height or with the use of a stationary or venting transom.

Sliders	Interlocking fins and steam foam can be added to a slider for steam use. This makes the functional steam unit and is 75% steam efficient.	Add \$106 to list price
Hinged Doors	A combination of a magnet header, magnet cross piece, and stryker frame section can be added to hinged doors to obtain a tight fit. This type of enclosure is the most effective for a steam unit.	Add \$204 to list price

STEAM UNITS MADE WITH A TRANSOM

A stationary transom can be installed over a standard height door to make the enclosure steam efficient. The unit the transoms are installed over need a steam kit (see above).

L-98 STATIONARY TRANSOM			
MODEL	WIDTH	HEIGHT	LIST PRICE
L-98	Up to 36"	Up to 12"	\$279
	Up to 40"		\$320
	Up to 50"		\$357
	Up to 60"		\$395

* Transoms over 12" in height will require custom glass- contact Century for pricing.

A hinged transom enables the shower to become steam proof with venting for steam to escape while showering. The unit the transoms are installed over need a steam kit (see above).

L-97 HINGED TRANSOM			
MODEL	WIDTH	HEIGHT	LIST PRICE
L-97	Up to 36"	8"-14"	\$673
	Up to 48"		\$769
	Up to 60"		\$864

* The minimum height required for a hinged transom is 8". Transoms over 14" in height will require custom glass- contact Century for pricing.

Anodized aluminum may vary in shade and color among extrusions. Color variance is considered within factory tolerances in the Anodizing Industry.

AVAILABLE UPGRADES FOR 5/32" GLASS

Glass Patterns/Tints	Sq.Ft. List Price
Aqualite (Spraylite)	\$33
Niagra (Rain)	\$33
Stipolite (Pattern 62)	\$33
Clear	\$13

AVAILABLE UPGRADES FOR 1/4" GLASS (FROM 5/32" CLEAR)

Glass Patterns/Tints	Sq.Ft. List Price
Low Iron	\$46
Niagra (Rain)	\$32
Stipolite (Pattern 62)	\$41
Aqualite (Spraylite)	\$72
Satin Etch (Mist)	\$46
Starphire	\$40
Reed	\$70

* Please call to check availability of ALL glass upgrades. Also, please note that Aqualite glass has inherent flaws in the pattern which cannot be avoided. We would recommend explaining this to any customers interested in this glass in order to set expectations.

Prices shown are per square foot and are incremental to clear glass price, so can be added to the unit list price.

Formula for Square Feet:

Door Width (inches) X Door Height (inches) ÷ 144 = SF

Example: 28" x 80" = 2240 ÷ 144 = 15.55 SF(Round to whole number)

	\$/SQ FT
Diamon Fusion	\$10

Diamon Fusion is a one-time, chemical treatment that is applied to and absorbed by the glass in order to add a layer of protection to the glass, reducing the required cleaning time.

(APPLIED TO BOTH SIDES OF THE GLASS)



spraylite

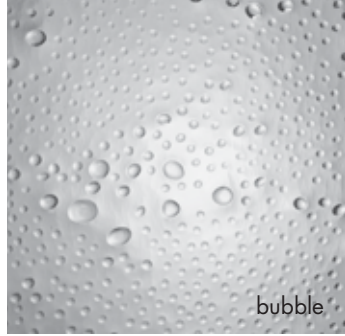

bubble

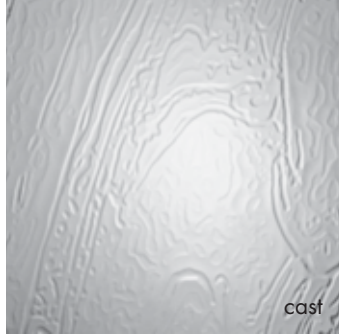

cast



stipolite (Pattern 62)



master carre

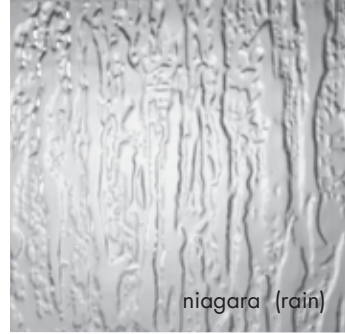

niagara (rain)

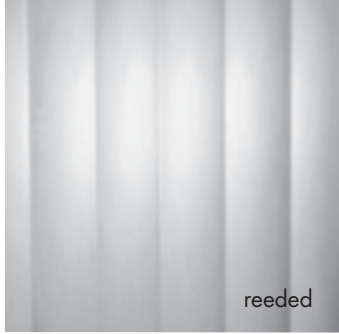

reeded



The optional Diamon-Fusion treatment helps protect the glass from the build up of soap scum and hard water deposits and reduces cleaning time by 50%. Applied to both sides of the glass, a vapor mist fills the natural microscopic peaks and valleys in the glass with a ultra thin optically clear durable material making it easier to clean. Simply wipe down with a washcloth or squeegee after showering.



Customers ask for ShowerGuard glass by name because it's the first and best permanent protective shower glass on the market. Wipe-on, spray-on alternatives may need to be periodically re-applied after use. ShowerGuard is applied to one side of the glass during the manufacturing process. Only ShowerGuard has a lifetime limited warranty.

Available in Standard Paint

DESCRIPTION		PRICE
Silver Anodized Aluminum	Bright, chrome-like finish	Standard for all Lucette models
Gold Anodized Aluminum	This finish will vary in shade and color among extrusions, but is within the tolerances established by the anodizing industry.	\$50 per panel
Satin Nickel	This finish is a deep brushed anodized finish	\$106 per panel
Standard Paint	Standard Colors for a baked enamel painted finish: Matte Black, Pearl White, & Oil Rubbed Bronze.	\$241 per panel
Custom Color Matching	Custom Color Matching can be obtained by submitting a tile, fabric, or paint sample. If the samples are muddled or marbelized, you must pick a solid color within the sample to match; variations cannot be matched.	\$241 per panel + \$495 setup

Anodized aluminum may vary in shade and color among extrusions. Color variance is considered within factory tolerances in the Anodizing Industry.

GRIDWORKS	
Aluminum	\$1,021 per door or panel

Simulated panes added to existing unit. Prices below would be added to the unit list price.

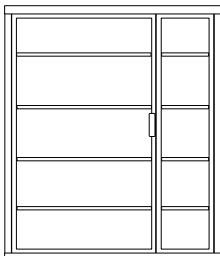

L-1627 w/Gridworks

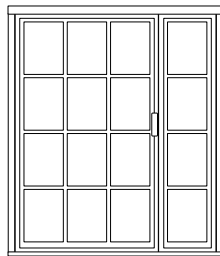

L-1627 w/Gridworks

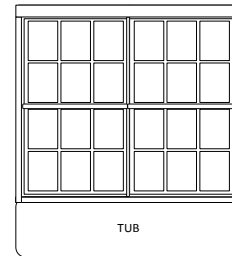







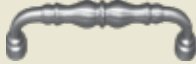

Bypass Tub w/ Gridworks

Available in Standard Paint

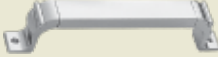
DESCRIPTION	PRICE (TO BE ADDED TO UNIT LIST PRICE)
Buttress (on existing in-line or return panel) (Converting a full height panel to buttress panel)	Slider return panels: \$86
	Hinged unit return panels: \$86
	Hinge unit in-line panels: \$12 per sq ft (Clear) \$23 per sq ft (Spraylite) (multiplied by sq footage of buttress panel)
Additional Inline Panel (Adding an additional panel inline, full height or on a buttress)	Up to 6" Spraylite or Clear: \$261
	Up to 12" Spraylite or Clear: \$292
	Up to 18" Spraylite or Clear: \$467
	Up to 24" Spraylite or Clear: \$529
Notched Panel (for enclosures w/ a buttress(es) (under 24 x 12))	Under 2 sq ft (24x12): \$191, plus custom glass
	Over 2 sq ft (24x12): \$232, plus custom glass
Frameless Mitered Corner (Glass with a 45° miter joining at the corner; no metal corner post) **Notched Panel is required- min 2 1/2" cline**	\$246 per corner added, plus custom glass
Special Angles, other than 135° Neo Angle Unit (1669):	\$246 per angle
Angle Ceiling Enclosure (glass cut to follow slope of the ceiling)	\$374 plus custom glass
Centec Header (round header, for bypass models)	\$84
Crown Molding Header	Hinged Doors: \$9 per ft
	Bypass Doors: \$11 per ft
Special Width (for units wider than those specified in the price lists)	\$106 per 6" over std width, plus custom glass
Special Height (for units taller than those specified in the price lists)	\$106 per 6" over std height, per panel, plus custom glass
Cutdown (for units shorter than those specified in the price lists)	\$71 per panel plus custom glass
Built-In Grilles	\$106 per panel
In-Swing Door (change piano-hinged door to swing- in; must specify hinge location)	\$84

Anodized aluminum may vary in shade and color among extrusions.
Color variance is considered within factory tolerances in the Anodizing Industry.

Available in Standard Paint

AVAILABLE HANDLES		
DESCRIPTION	6"	SAMPLES
C-Pull	\$84	
Spindle	\$197	
Bow	\$184	
Circle	\$184	
Highline Flat	\$226	
Square (Taiga)	\$184	
Ladder	\$380	
Coda	\$232	
Symphony	\$424	
Aria	\$424	
Concerto	\$325	

Anodized aluminum may vary in shade and color among extrusions.
Color variance is considered within factory tolerances in the Anodizing Industry.

Available Through Glass Handles (prices to be added to list price, **PLUS CUSTOM GLASS**)

Available in Standard Paint

AVAILABLE THROUGH GLASS TOWEL BARS (15", 18", 21", 24", 27", AND 30") (PRICES TO BE ADDED TO LIST PRICE, PLUS CUSTOM GLASS)		
DESCRIPTION	SET OF 2 TOWEL BARS (NOT BACK TO BACK, FOR SLIDER MODELS)	SAMPLES
Modern	\$123	
Traditional	\$274	
Spindle	\$471	
Bow (18" & 24" only)	\$359	
Square (Taiga, 18" & 24" only)	\$400	
Aria (24" only)	\$807	
Coda (18" & 24" only)	\$362	
Symphony (24" & 30" only)	\$588	
Concerto (24" & 30" only)	\$711	

Anodized aluminum may vary in shade and color among extrusions.
 Color variance is considered within factory tolerances in the Anodizing Industry.

Standard Lucette Towel Bar can be built onto the frame of hinged door, instead of the standard handle package—Add \$106 to unit list price.

Standard Lucette Towel Bar can also be surface mounted on a stationary panel—Add \$106 to unit list price.

Additional towel bars are available, including back to back towel bars for hinged models. Please call for pricing.

Available in Standard Paint

	DESCRIPTION	PRICE
Straight Fillers (Slider or Hinged Models)	Up to 1/2" filler to the wall or base	Add \$50 to list price, per jamb
	Up to 1" filler to the wall or base	Add \$63 to list price, per jamb
Tapered Fillers (Slider or Hinged Models)	Custom made filler cut per customer specification for out of plumb or out of level conditions	0-1"- Add \$120 to list price, per filler
		1-2"- Add \$191 to list price, per filler
		Over 2"- contact Century for a quote.
Telescopic Expanders (Slider Models ONLY)	Used when wall of 2 door slider is out of plumb. Expander attaches to wall and side jamb is inserted into it. Jamb can now be adjusted from 0-3/4" by moving jamb inside of the expander.	Add \$78 to list price, per jamb

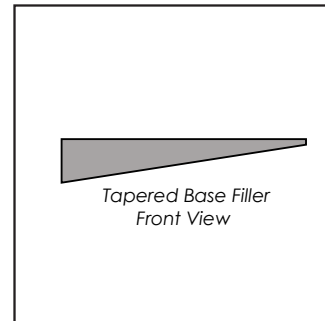
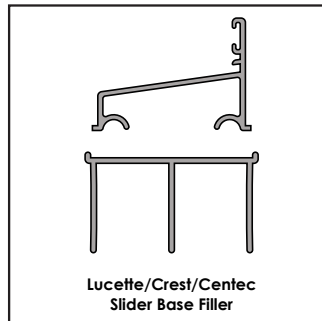
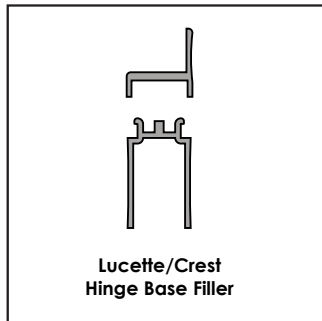
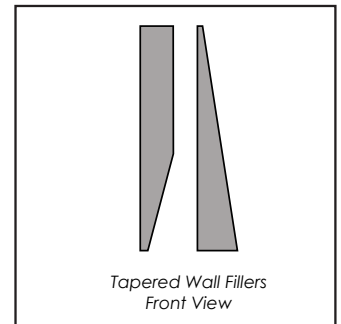
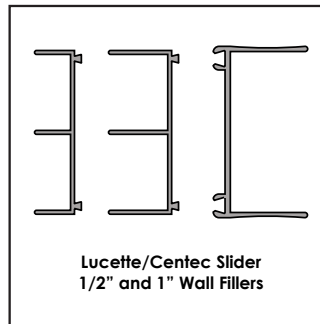
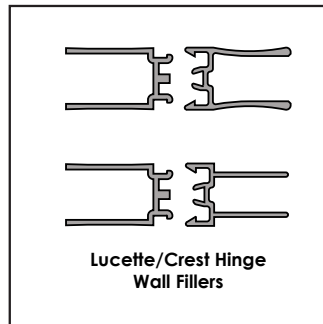
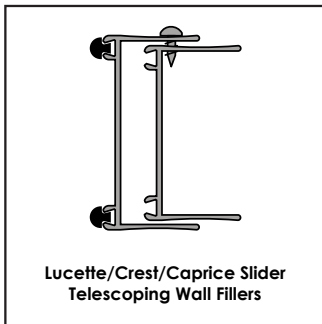

Anodized aluminum may vary in shade and color among extrusions.
Color variance is considered within factory tolerances in the Anodizing Industry.