

**BF 70**  
**Centec Bifold Door**  
**Installation Guide**

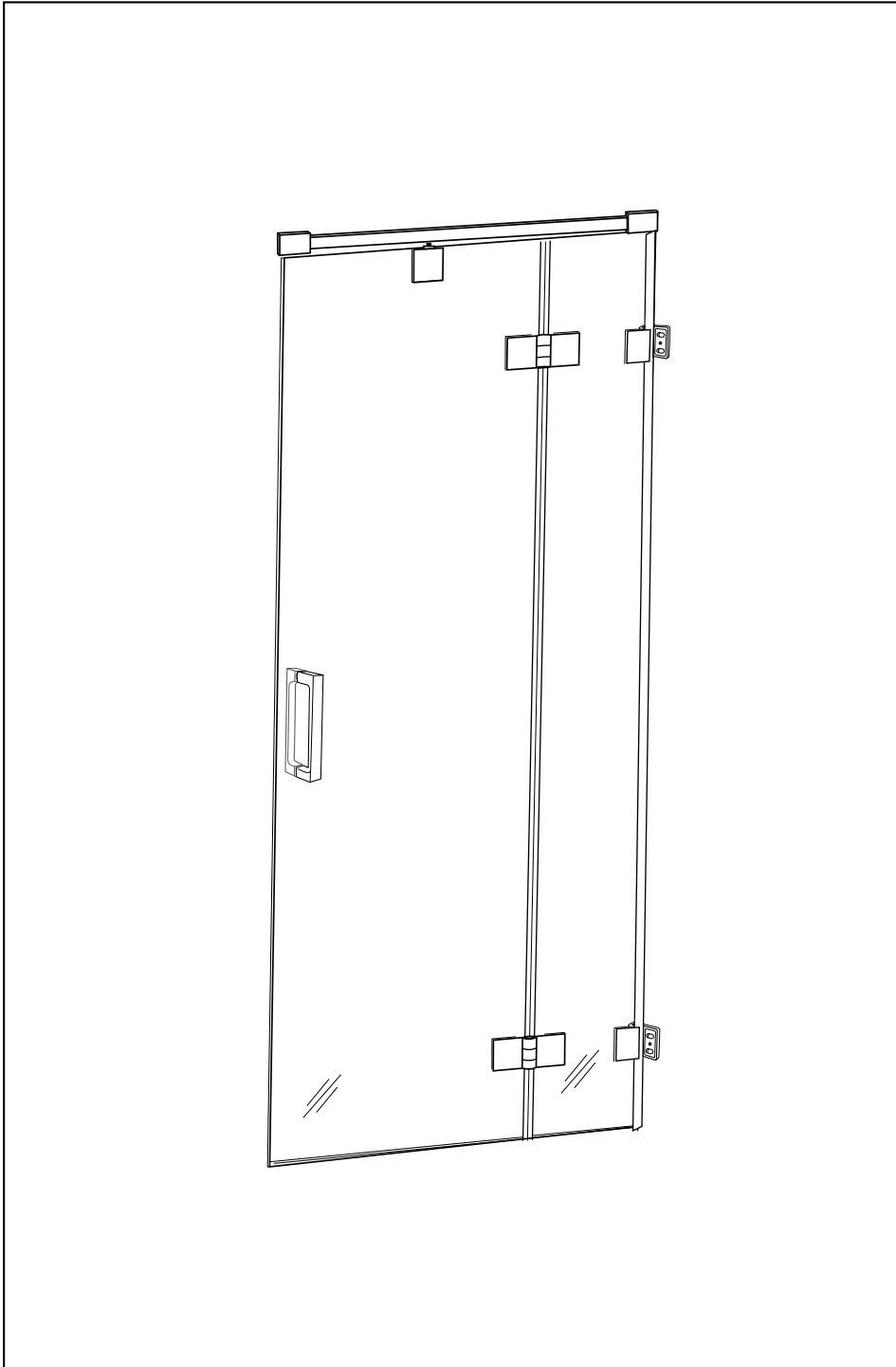

Detailed diagram of BF 70 components

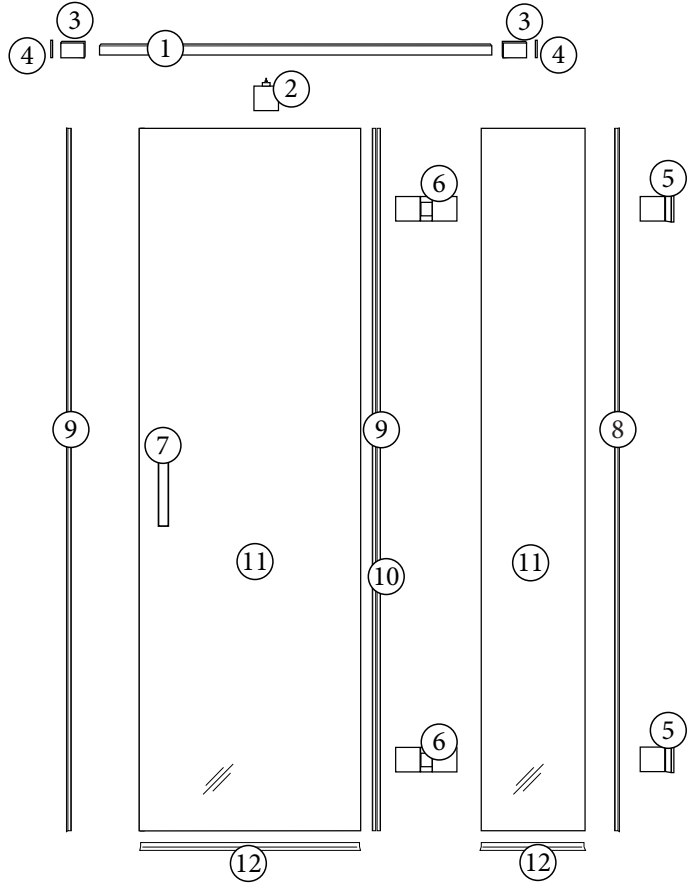

#	Part Name	Qty
1	Sliding Rail	1
2	Rail track clamp	1
3	Rail to Wall Connect	2
4	Wall bracket	2
5	Wall hinge	2
6	Door hinge	2
7	C handle	1
8	Sealing vinyl glass-to-glass	1
9	Sealing vinyl	2
10	H vinyl	1
11	Glass doors	2
12	Deflector sweep vinyl	1
<i>See parts list below:</i>		
13	Handle hardware	2
14	Allen wrenches	1
15	Screws	4
16	Set screws	4
17	Countersunk Allen bolts	8
18	Anchors	6
19	Steel/Neoprene washers	2

**Parts List**

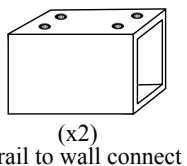
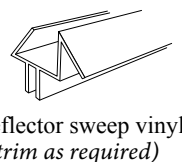
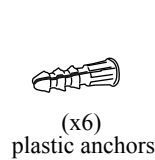
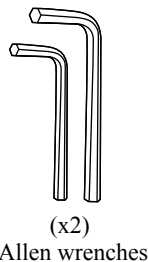
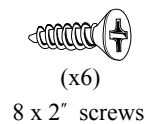
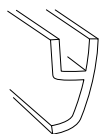
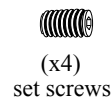
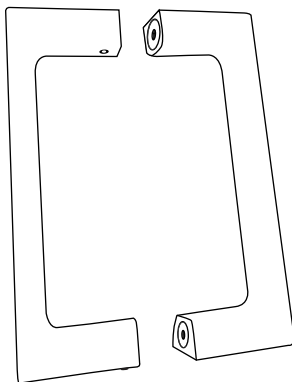
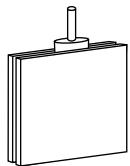
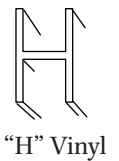
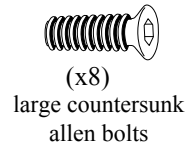
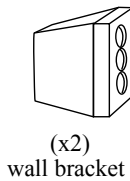
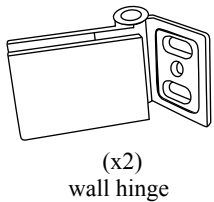
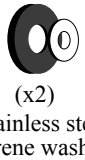
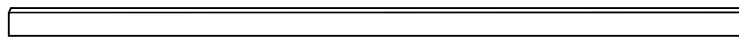
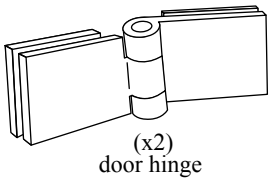

**Tools required**

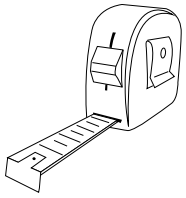

Tape Measure

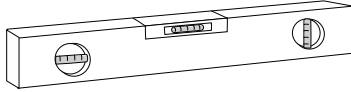

Level

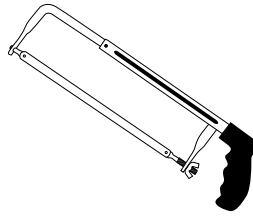

Hacksaw  
(or Chopsaw w/metal blade)

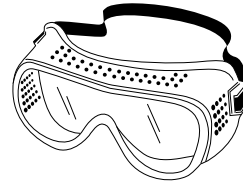

Safety glasses



Pencil/Marker



Drill bit  
3/16" carbide masonry bit

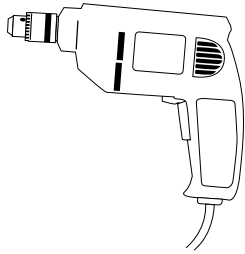

Drill

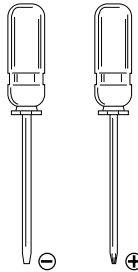

Flat and Phillips  
head Screwdrivers

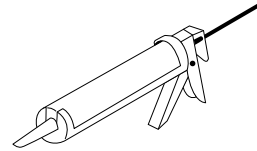

Caulk gun



Piece of carpet/ padding

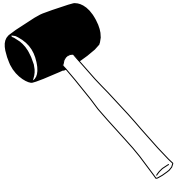

Rubber mallet

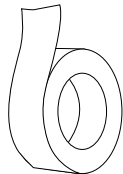

Masking tape

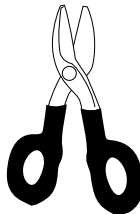

Scissors

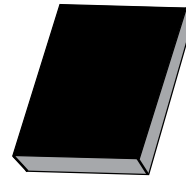

Glazing block/  
piece of wood (2"x 4")

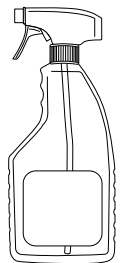

Glass cleaner



**WARNINGS**

- \*\*Before starting, please read instructions carefully and thoroughly; then proceed step by step.
- \*\*Please wear safety glasses and safety gloves whenever drilling or cutting tile or handling metal/glass parts.
- \*\*When drilling through tile, carefully break through glazed surface only with sharp tool and then drill slowly.
- \*\*Wall uprights must be installed level and plumb. Do not follow grout lines.
- \*\*To insure complete customer satisfaction Century Bathworks recommends installation by a professional.
- \*\*Risk of injury or product damage. Two people should perform this installation.
- \*\*Do not cut the top and bottom track the same length for this installation.
- \*\*Please carefully unpack all parts for your unit as listed on previous page and also check that you have all the tools as listed above.
- \*\*If any parts are missing or damaged, please contact Century Bathworks or your dealer for replacements.

1

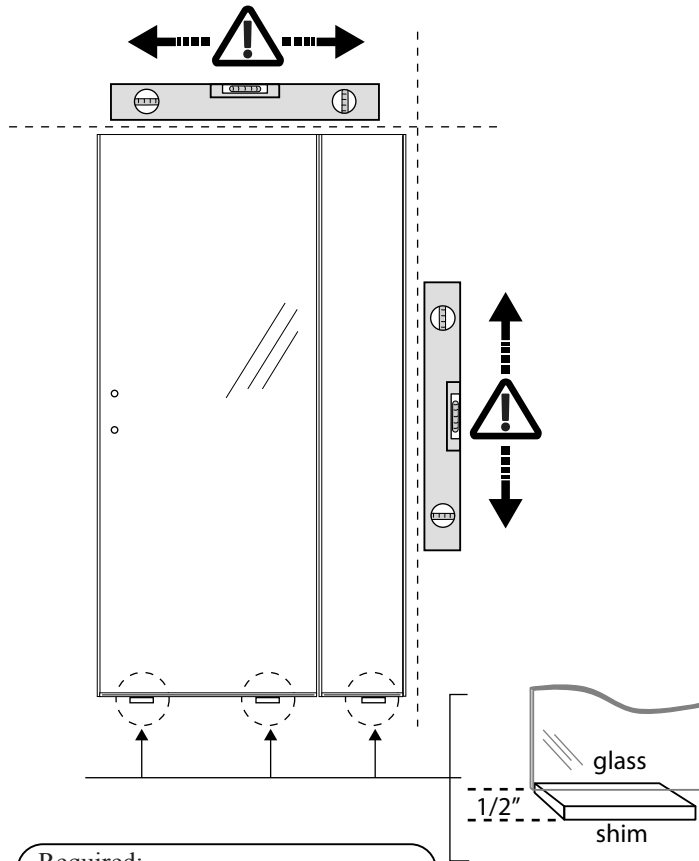

Required:  
Rubber mallet, level, pencil/marker

- Rest door on 1/2" shims over centerline of opening.

2

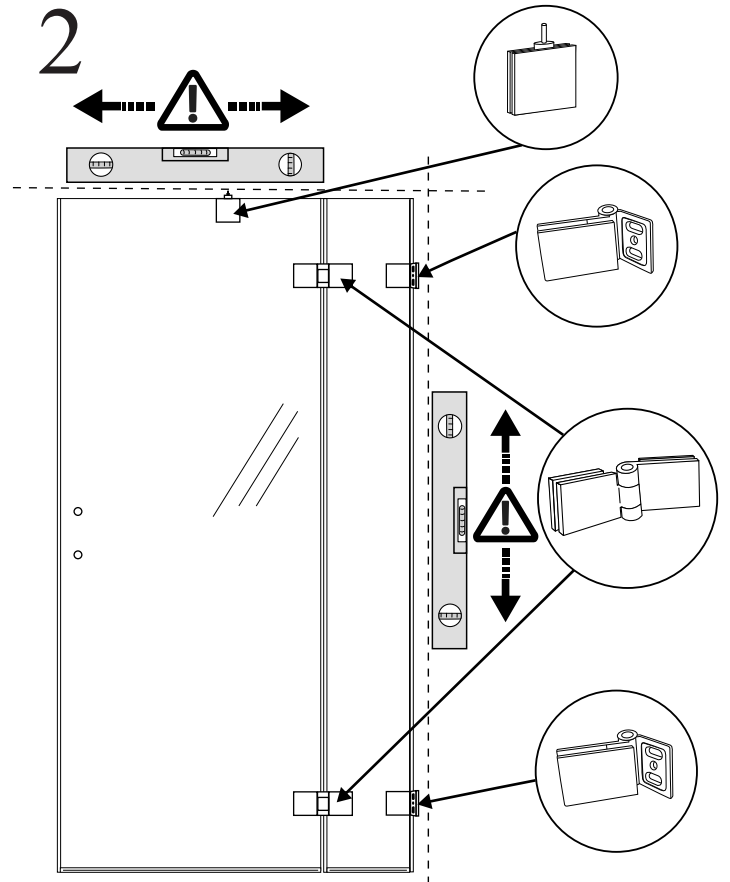

Required:  
Rubber mallet, level, pencil/marker

- Plumb door with hinges resting against the wall and transfer mounting hole locations.

3

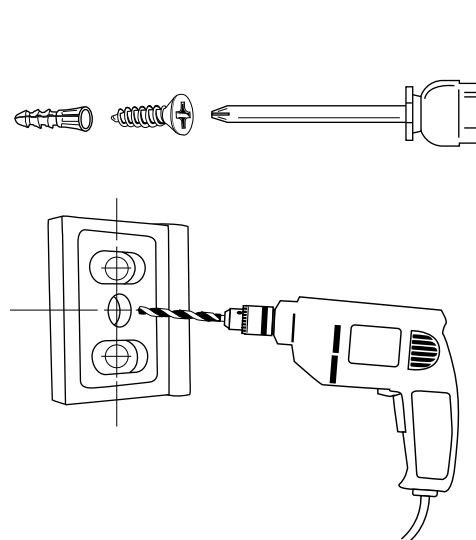

Required:  
#32 metal drill bit, screwdriver, tape measure

- Remove the door and drill pilot holes for appropriate wall anchors or screws.

4

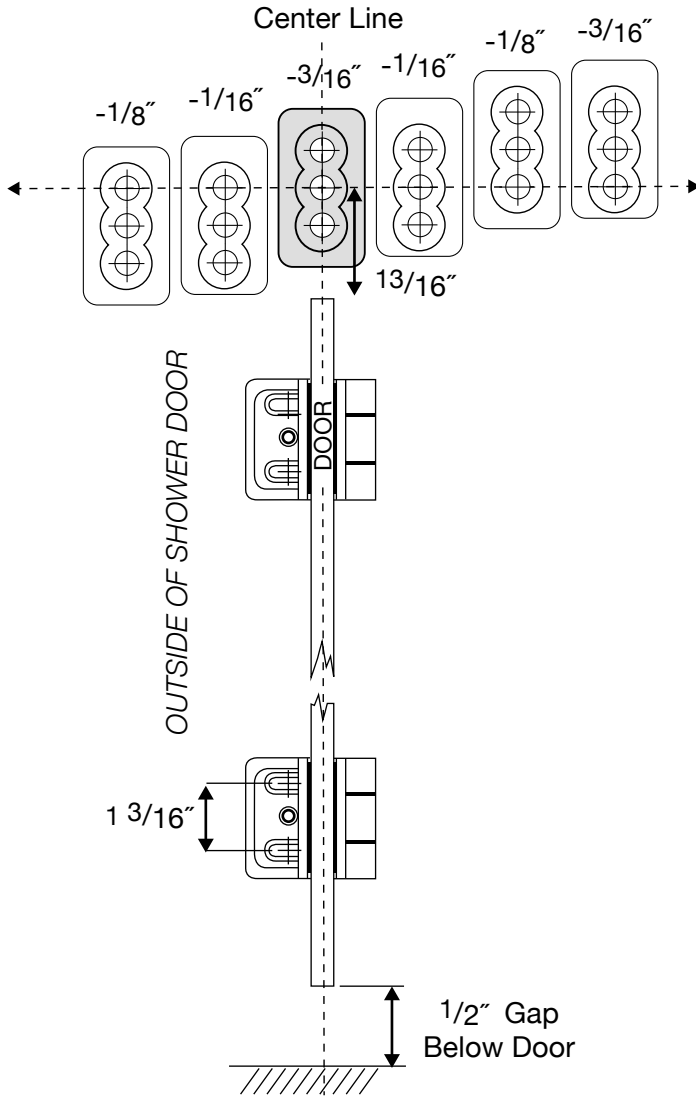

Required:  
#32 metal drill bit, pencil/marker

- Mark 13/16" above door on centerline of each wall. Drill appropriate holes for anchors and wall brackets.

5

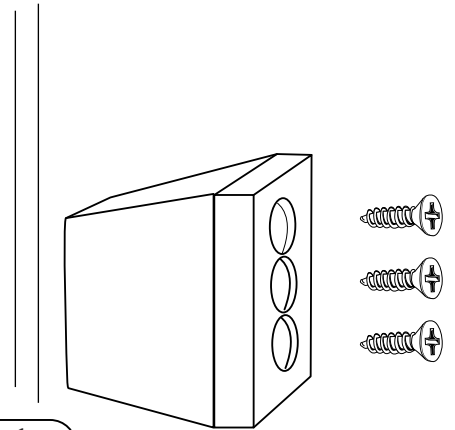

Required:  
Screwdriver

- Mount wall brackets

6

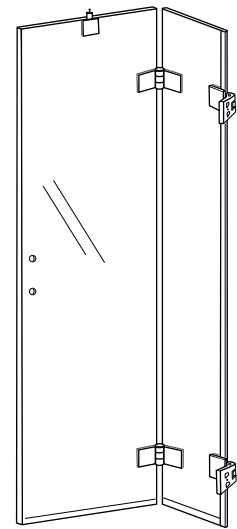

Required:  
Screwdriver

- Adjust door to the open position.

7

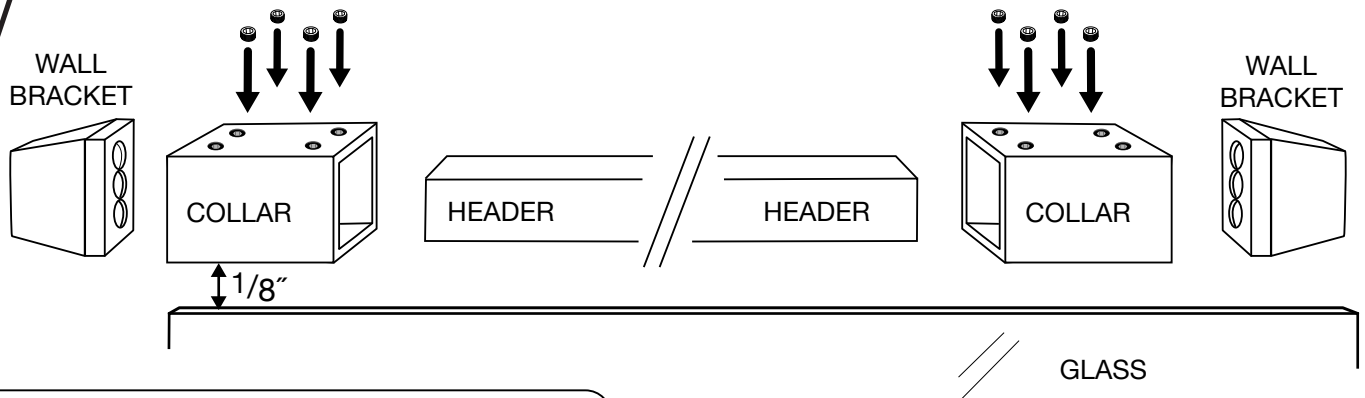

Required:  
Rubber mallet, allen wrench, screwdriver, tape measure

- Slide collars onto header. Align rail with wall brackets and slide collars over wall brackets. Tighten set screws to wall brackets first. then tighten set screws to header. Collars should have a 1/8" gap above the door.

8

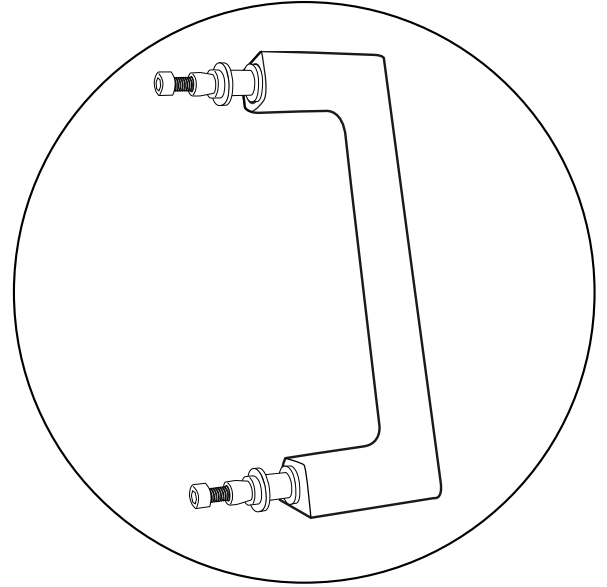
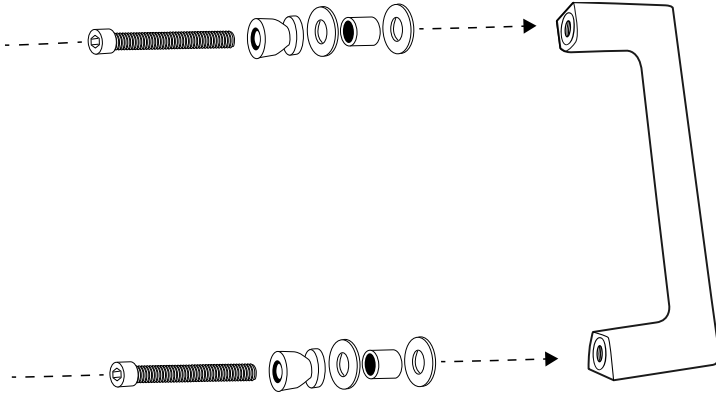

Required:  
allen wrench

- Assemble and install handles

9

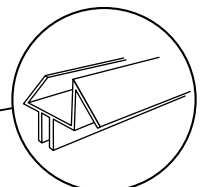
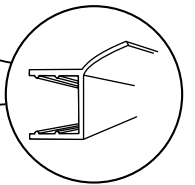
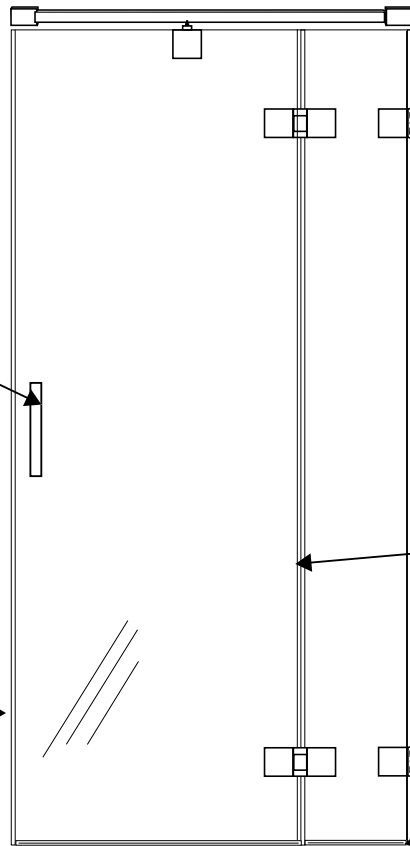
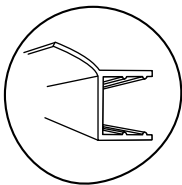
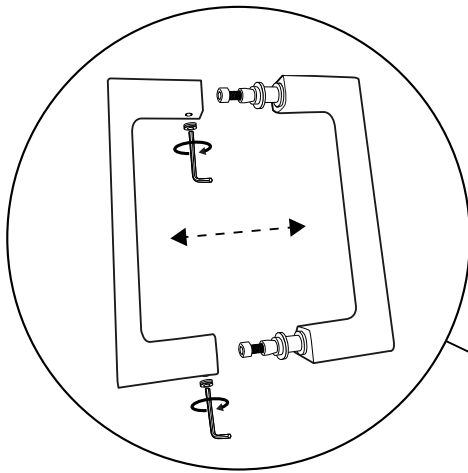

Required:  
Rubber mallet, allen wrench

- Install handles and seals on glass edges