

# CENTEC

PRICE BOOK



**CENTURY**

BATHWORKS

---

973-785-4290 • 800-524-2578 • FAX 973-785-0777

SUMMARY ..... 3

BIFOLD (1/4”) ..... 4 - 5

SELECT ..... 6

PREMIER ..... 7

CT/CS MODELS ..... 8 - 20

CH MODELS ..... 21 - 23

CHX MODELS ..... 24 - 26

GLASS UPGRADES ..... 27 - 28

HANDLES ..... 29

TOWEL BARS ..... 30

DECORATIVE FINISHES ..... 31

CUSTOM GLASS FABRICATION ..... 32

FILLERS ..... 33

<b>TOP ROLLING SLIDER (BARN DOOR)</b>
Centec Select
Centec Select w/ 90° Return
Centec Premier

<b>SOLID BRASS FRAMELESS SLIDER MODELS</b>	
CT	Tub Enclosure
CS	Stall Enclosure
CT-670	Tub Enclosure w/ Inline Panel
CS-1670	Stall Enclosure w/ Inline Panel
CT-636	Tub Enclosure w/ 90° return
CS-1648	Stall Enclosure w/ 90° return

**SEMI-FRAMELESS HINGE ENCLOSURES**

Hinge/Mount Type:	CH	CHX
	Aluminum Continuous Pivot Hinge	Aluminum Patch Hinge (Crossover Model)
	Hinge along entire length of door and attaches to channel	Patch hinges attach glass to wall channel
CONFIGURATIONS		
36		
64		
70	X	X
71		
72		
1627	X	X
1628	X	X
1629		
1630	X	X
1631	X	X
1669	X	X
1669 2/3	X	X

The table above is meant to display all available Centec hinge door models. An “X” indicates that the configuration is available for the corresponding hinge type. The following pages include pricing for the majority of models, though some have been excluded to simplify the book. Please contact us if you would like pricing for any enclosure that is not included in the book- we would be happy to help.

## BIFOLD MODELS

### STANDARD FEATURES ON BIFOLD MODELS

- Bifold Doors operate with the ease of a conventional door
- Handle swings in a natural, ergonomic path
- Slim 1" square brass header
- Ideal for tight spaces-Easily clears vanities and toilets
- Ideal for ADA applications
- Fully opened doors create a safer environment while bathing young children in bathtub applications

Available in Standard Paint

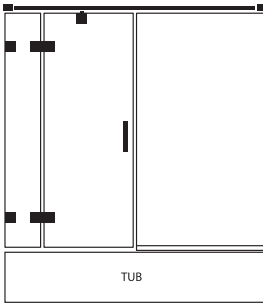

BF-1627-BIFOLD 1/4" GLASS				
Finish	Width	48"	54"	60"
Chrome	62" Height	\$2,382	\$2,493	\$2,609
Satin Nickel	62" Height	\$2,505	\$2,618	\$2,732
Matte Black	62" Height	\$2,438	\$2,551	\$2,665

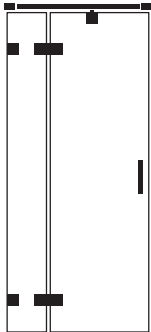

BF-70-BIFOLD 1/4" GLASS							
Finish	Width	20"	22"	24"	26"	28"	30"
Chrome	76" Height	\$1,678	\$1,708	\$1,753	\$1,800	\$1,845	\$1,892
Satin Nickel	76" Height	\$1,801	\$1,830	\$1,980	\$1,922	\$1,968	\$2,015
Matte Black	76" Height	\$1,732	\$1,764	\$1,809	\$1,856	\$1,901	\$1,883

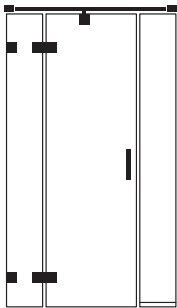

BF-1627-BIFOLD 1/4" GLASS									
Finish	Width	30"	34"	38"	42"	46"	50"	54"	60"
Chrome	76" Height	\$2,168	\$2,255	\$2,347	\$2,439	\$2,532	\$2,624	\$2,717	\$2,856
Satin Nickel	76" Height	\$2,291	\$2,378	\$2,470	\$2,562	\$2,655	\$2,747	\$2,820	\$2,978
Matte Black	76" Height	\$2,223	\$2,310	\$2,403	\$2,495	\$2,588	\$2,783	\$2,772	\$2,910

Anodized aluminum may vary in shade and color among extrusions. Color variance is considered within factory tolerances in the Anodizing Industry.

**BIFOLD MODELS**

**STANDARD FEATURES ON BIFOLD MODELS**

- Bifold Doors operate with the ease of a conventional door
- Handle swings in a natural, ergonomic path
- Slim 1" square brass header
- Ideal for tight spaces-Easily clears vanities and toilets
- Ideal for ADA applications
- Fully opened doors create a safer environment while bathing young children in bathtub applications

**Available in Standard Paint \* Buttress available**

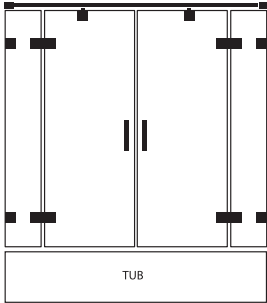

<b>BF-1629-BIFOLD 1/4" GLASS (ADA)</b>				
Finish	Width	48"	54"	60"
Chrome	62" Height	\$3,084	\$3,141	\$3,255
Satin Nickel	62" Height	\$3,188	\$3,301	\$3,413
Matte Black	62" Height	\$3,094	\$3,206	\$3,319

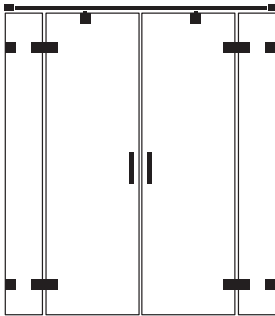

<b>BF-1629-BIFOLD 1/4" GLASS (ADA)</b>							
Finish	Width	40"	44"	48"	52"	56"	60"
Chrome	76" Height	\$3,104	\$3,196	\$3,288	\$3,380	\$3,472	\$3,564
Satin Nickel	76" Height	\$3,262	\$3,355	\$3,448	\$3,540	\$3,632	\$3,724
Matte Black	76" Height	\$3,169	\$3,261	\$3,354	\$3,446	\$3,538	\$3,632

Anodized aluminum may vary in shade and color among extrusions. Color variance is considered within factory tolerances in the Anodizing Industry.

## HEAVY GLASS TOP ROLLING SLIDER

### STANDARD FEATURES ON CENTEC SELECT

- Top rolling 3/8" clear heavy glass sliding enclosure
- 3/4" stainless steel header bar
- 4 stainless steel rollers with concealed ball bearings
- Standard back to back 16" ladder pull handles- 12" center-to-center hole location
- Fixed panel opposite sliding panel with a 2 1/2" overlap
- Water dam
- U channel under panels
- For 90° return model: stationary wall clips on return panel & top mounted corner clip

Available in Standard Paint

\* Buttress available

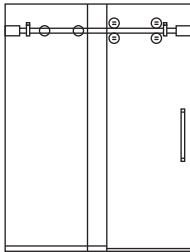

CENTEC SELECT			
MIN TO MAX WIDTH	HEIGHT	SATIN STAINLESS	POLISHED STAINLESS
46" TO 54"	76"	\$2,835	\$3,042
54" TO 57"		\$3,236	\$3,443
57" TO 62"		\$3,412	\$3,619
54" TO 57"	62 3/4"	\$2,798	\$3,005
57" TO 62"	62 3/4"	\$3,035	\$3,242

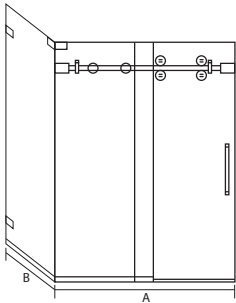

CENTEC SELECT WITH 90° RETURN PANEL			
MIN TO MAX WIDTH	HEIGHT	SATIN STAINLESS	POLISHED STAINLESS
46" TO 54" w/ return up to 36"	76"	\$4,799	\$5,006
46" TO 54" w/ return up to 42"		\$5,008	\$5,215
46" TO 54" w/ return up to 48"		\$5,218	\$5,425
54" TO 57" w/ return up to 36"		\$4,939	\$5,146
54" TO 57" w/ return up to 42"		\$5,148	\$5,355
54" TO 57" w/ return up to 48"		\$5,357	\$5,564
57" TO 62" w/ return up to 36"		\$5,079	\$5,256
57" TO 62" w/ return up to 42"		\$5,288	\$5,495
57" TO 62" w/ return up to 48"		\$5,497	\$5,704

Anodized aluminum may vary in shade and color among extrusions.  
Color variance is considered within factory tolerances in the Anodizing Industry.

# HEAVY GLASS TOP ROLLING BYPASS SLIDER

## STANDARD FEATURES ON CENTEC PREMIER

- Top rolling 3/8" clear heavy glass sliding enclosure
- 2" header bar
- Tear drop shaped hardware conceals roller mechanism
- Adjustable Rollers allow outages up to 3/8" on the wall and 1/4" on the base
- 2" recessed cup handle. Other hardware options are available- call for pricing.
- Recommended overlap between the 2 doors is 2-4"
- Water dam included under door
- Cushioned vinyl protects glass edge
- Custom sizes available with a max width of 66" and a max height of 80"
- Soft Close feature

**Available in Standard Paint**

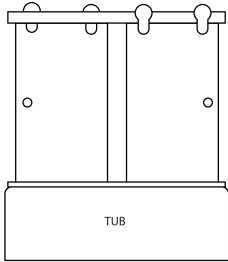

CENTEC PREMIER, BYPASS TUB					
MIN TO MAX WIDTH	HEIGHT	SATIN STAINLESS	POLISHED STAINLESS	OIL RUBBED BRONZE, MATTE BLACK	SATIN GOLD
57-59"	62"	\$2,009	\$2,051	\$2,258	\$3,226
57-59"	66"	\$2,054	\$2,094	\$2,302	\$3,256

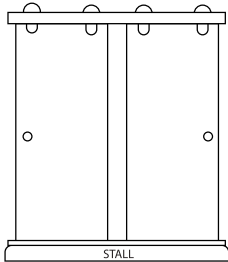

CENTEC PREMIER, STALL BYPASS					
MIN TO MAX WIDTH	HEIGHT	SATIN STAINLESS	POLISHED STAINLESS	OIL RUBBED BRONZE, MATTE BLACK	SATIN GOLD
45 - 47"	72"	\$1,812	\$1,855	\$2,208	\$2,586
57 - 59"		\$2,120	\$2,160	\$2,367	\$3,302
45 - 47"	76"	\$1,847	\$1,891	\$2,242	\$3,220
57 - 59"		\$2,164	\$2,204	\$2,412	\$3,333

Anodized aluminum may vary in shade and color among extrusions. Color variance is considered within factory tolerances in the Anodizing Industry.

## SEMI-FRAMELESS BYPASS SLIDERS

### STANDARD FEATURES ON CENTEC CT / CS

- Round or Flat Header. Round will be supplied unless specified
- \*\*Crown Molding Header Available at an additional charge. Available in Silver, Gold, Satin Nickel, & Oil Rubbed Bronze Finishes only. Crown header not available in a reinforced header.
- Pricing shown assumes Clear tempered glass (1/4" or 3/8" as indicated) (All in-line & return panels are 1/4" glass)
- Standard finish is chrome anodized aluminum, but other finishes are available
- Polished Nickel finish only available with a flat header
- Anti-jump safety clips
- Modern Towel Bars come standard
- Fillers are available for out of plumb and out of level conditions. See page 30 for details.
- Consult factory when overlap is at a minimum or maximum range. Excessive overlap will decrease pass thru.
- Custom configurations are available for most bypass units, including additional inline panels, buttress panels, angle cut panels or doors to follow the slope of the ceiling, etc. Please contact us for details.

Available in Standard Paint

\* Buttress available

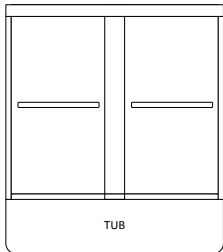

CT- BYPASS TUB W/ 1/4" GLASS							
	MODEL	MIN TO MAX WIDTH	HEIGHT	SILVER	GOLD	SATIN NICKEL/ POLISHED NICKEL	STANDARD PAINT
1/4" CLEAR	CT 4 *	42 1/2" TO 48"	57 3/4"	\$982	\$1,080	\$1,143	\$1,494
	CT 4.5	48" TO 53 1/2"					
	CT 5 *	54" TO 59 1/2"					
	CT 5.5 *	60" TO 65 1/2"	57 3/4"	\$1,027	\$1,124	\$1,187	\$1,538
	CT 6 *	66" TO 71 1/2"	57 3/4"	\$1,071	\$1,168	\$1,143	\$1,582
	CT 51-56 *	48" TO 53 1/2"	56"	\$955	\$1,052	\$1,116	\$1,466
	CT 56-56	52" TO 57"					
1/4" BUBBLE	CT 4	42 1/2" TO 48"	57 3/4"	\$1,639	\$1,810	\$1,823	\$2,248
	CT 4.5	48" TO 53 1/2"					
	CT 5	54" TO 59 1/2"	CALL FOR QUOTE				
	CT 5.5	60" TO 65 1/2"	57 3/4"	\$1,796	\$1,966	\$1,972	\$2,410
	CT 6	66" TO 71 1/2"	57 3/4"	\$1,888	\$2,045	\$2,086	\$2,535
	CT 51-56	48" TO 53 1/2"	56"	\$1,672	\$1,772	\$1,776	\$2,170
	CT 56-56	52" TO 57"					

\*Available in 1 hole glass with knob

Standard Colors include: Pearl White, Oil Rubbed Bronze, Matte Black. Custom color matching is also available for most Centec models- please call for pricing.

Anodized aluminum may vary in shade and color among extrusions.  
Color variance is considered within factory tolerances in the Anodizing Industry.



Available in Standard Paint \* Buttress available

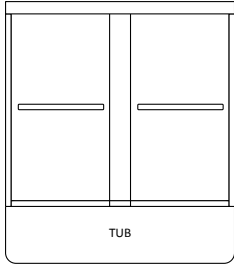

CTX- TALLER BYPASS TUB W/ 1/4" GLASS							
	MODEL	MIN TO MAX WIDTH	HEIGHT	SILVER	GOLD	SATIN NICKEL/ POLISHED NICKEL	STANDARD PAINT
1/4" CLEAR	CTX 4.5 *	48" TO 53 1/2"	62 3/4"	\$1,005	\$1,102	\$1,188	\$1,516
	CTX 5 *	54" TO 59 1/2"					
	CTX 5	54" TO 59 1/2"	66"	\$1,052	\$1,135	\$1,250	\$1,539
	CTX 5.5	60" TO 65 1/2"	62 3/4"	\$1,098	\$1,169	\$1,282	\$1,609
	CTX 6 *	66" TO 71 1/2"					
1/4" BUBBLE	CTX 4.5	48" TO 53 1/2"	CALL FOR QUOTE				
	CTX 5	54" TO 59 1/2"					
	CTX 5	54" TO 59 1/2"					
	CTX 5.5	60" TO 65 1/2"					
	CTX 6	66" TO 71 1/2"					

\*Available in 1 hole glass with knob

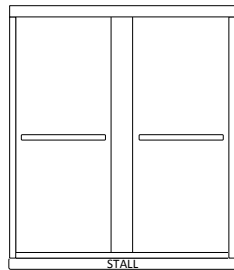

CS- STALL BYPASS W/ 1/4" GLASS							
	MODEL	MIN TO MAX WIDTH	HEIGHT	SILVER	GOLD	SATIN NICKEL/ POLISHED NICKEL	STANDARD PAINT
1/4" CLEAR	CS 3.5 *	36" TO 41 1/2"	70 3/4"	\$995	\$1,080	\$1,193	\$1,464
	CS 4 *	42" TO 47 1/2"					
	CS 4.5	48" TO 53 1/2"	70 3/4"	\$1,102	\$1,187	\$1,299	\$1,565
	CS 5 *	54" TO 59 1/2"					
	CS 5.5	60" TO 65 1/2"	70 3/4"	\$1,182	\$1,266	\$1,379	\$1,633
	CS 4466	40" TO 45"	66"	\$984	\$1,069	\$1,183	\$1,438
1/4" BUBBLE	CS 3.5	36" TO 41 1/2"	70 3/4"	\$1,668	\$1,766	\$1,798	\$2,180
	CS 4	42" TO 47 1/2"					
	CS 4.5	48" TO 53 1/2"	CALL FOR QUOTE				
	CS 5	54" TO 59 1/2"					
	CS 5.5	60" TO 65 1/2"					
	CS 4466	40" TO 45"					

\*Available in 1 hole glass with knob

Anodized aluminum may vary in shade and color among extrusions. Color variance is considered within factory tolerances in the Anodizing Industry.

Available in Standard Paint

\* Buttruss available

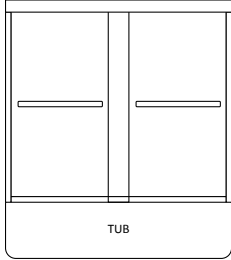

CT-BYPASS TUB W/ 3/8" GLASS							
	MODEL	MIN TO MAX WIDTH	HEIGHT	SILVER	GOLD	SATIN NICKEL/ POLISHED NICKEL	STANDARD PAINT
3/8" CLEAR	CT 4	42 1/2" TO 48"	57 3/4"	\$1,277	\$1,439	\$1,469	\$1,778
	CT 4.5	48" TO 53 1/2"					
	CT 5 *	54" TO 59 1/2"					
	CT 5.5	60" TO 65 1/2"		\$1,393	\$1,495	\$1,586	\$1,839
	CT 6	66" TO 71 1/2"		\$1,463	\$1,563	\$1,655	\$1,901
	CT 51-56	48" TO 53 1/2"	56"	\$1,238	\$1,336	\$1,427	\$1,740
	CT 56-56	52" TO 57"					
3/8" BUBBLE	CT 4	42 1/2" TO 48"	57 3/4"	CALL FOR QUOTE			
	CT 5	54" TO 59 1/2"					
	CT 5.5	60" TO 65 1/2"					
	CT 6	66" TO 71 1/2"					
	CT 51-56	48" TO 53 1/2"	56"				

\*Available in 1 hole glass with knob

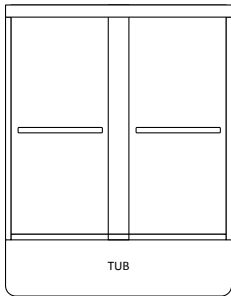

CTX-TALLER BYPASS TUB W/ 3/8" GLASS							
	MODEL	MIN TO MAX WIDTH	HEIGHT	SILVER	GOLD	SATIN NICKEL/ POLISHED NICKEL	STANDARD PAINT
3/8" CLEAR	CTX 4.5	48" TO 53 1/2"	62 3/4"	\$1,421	\$1,521	\$1,614	\$1,860
	CTX 5 *	54" TO 59 1/2"					
	CTX 5 *	54" TO 59 1/2"	66"	\$1,460	\$1,560	\$1,653	\$1,899
	CTX 5.5	60" TO 65 1/2"	62 3/4"	\$1,567	\$1,667	\$1,760	\$2,008
	CTX 6	66" TO 71 1/2"					
3/8" BUBBLE	CTX 5	54" TO 59 1/2"	CALL FOR QUOTE				
	CTX 5.5	60" TO 65 1/2"					
	CTX 6	66" TO 71 1/2"					

\*Available in 1 hole glass with knob

Anodized aluminum may vary in shade and color among extrusions. Color variance is considered within factory tolerances in the Anodizing Industry.

Available in Standard Paint \* Buttress available

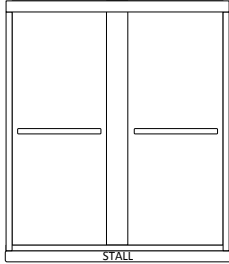

CS- STALL BYPASS W/ 3/8" GLASS							
	MODEL	MIN TO MAX WIDTH	HEIGHT	SILVER	GOLD	SATIN NICKEL/ POLISHED NICKEL	STANDARD PAINT
3/8" CLEAR	CS 3.5	36" TO 41 1/2"	70 3/4"	\$1,440	\$1,539	\$1,631	\$1,877
	CS 4 *	42" TO 47 1/2"					
	CS 4.5	48" TO 53 1/2"		\$1,558	\$1,657	\$1,749	\$1,995
	CS 5 *	54" TO 59 1/2"					
	CS 5.5	60" TO 65 1/2"	\$1,642	\$1,739	\$1,832	\$2,079	
	CS 4466	40" TO 45"	66"	\$1,291	\$1,389	\$1,482	\$1,728
3/8" BUBBLE	CS 3.5	36" TO 41 1/2"	70 3/4"	CALL FOR QUOTE			
	CS 4	42" TO 47 1/2"					
	CS 4.5	48" TO 53 1/2"					
	CS 5	54" TO 59 1/2"					
	CS 5.5	60" TO 65 1/2"					
	CS 4466	40" TO 45"	66"				

Shaded models indicate that a strengthened header will be used due to excessive weight. This adds 3/8" to Height.

\*Available in 1 hole glass with knob

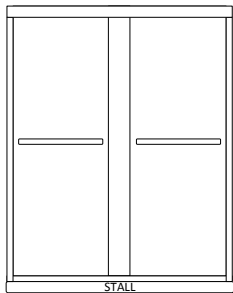

CSX-TALLER STALL BYPASS W/ 3/8" GLASS							
	MODEL	MIN TO MAX WIDTH	HEIGHT	SILVER	GOLD	SATIN NICKEL/ POLISHED NICKEL	STANDARD PAINT
3/8" CLEAR	CSX 3.5	36" TO 41 1/2"	76"	\$1,528	\$1,626	\$1,719	\$1,965
	CSX 4	42" TO 47 1/2"					
	CSX 4.5	48" TO 53 1/2"		\$1,708	\$1,808	\$1,899	\$2,148
	CSX 5 *	54" TO 59 1/2"					
	CSX 5.5	60" TO 65 1/2"		\$1,800	\$1,898	\$1,991	\$2,238
3/8" BUBBLE	CSX 5	54" TO 59 1/2"	76"	CALL FOR QUOTE			

Shaded models indicate that a strengthened header will be used due to excessive weight. This adds 3/8" to Height.

\*Available in 1 hole glass with knob

Anodized aluminum may vary in shade and color among extrusions.  
Color variance is considered within factory tolerances in the Anodizing Industry.

Available in Standard Paint \* Buttruss available

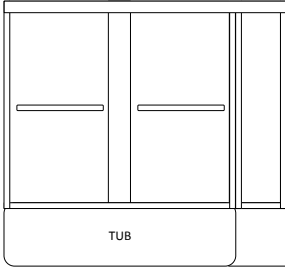

CT-670- BYPASS TUB WITH PANEL W/ 1/4" GLASS							
	MODEL	MIN TO MAX WIDTH	HEIGHT	SILVER	GOLD	SATIN NICKEL	STANDARD PAINT
1/4" CLEAR	CT-670	48" TO 59 1/2" w/Panel up to 12"	57 3/4"	\$1,306	\$1,452	\$1,642	\$2,073
		48" TO 59 1/2" w/Panel up to 18"		\$1,403	\$1,549	\$1,738	\$2,170
		48" TO 59 1/2" w/Panel up to 24"		\$1,516	\$1,662	\$1,851	\$2,277
		60" TO 71 1/2" w/Panel up to 12"		\$1,415	\$1,562	\$1,750	\$2,183
		60" TO 71 1/2" w/Panel up to 18"		\$1,512	\$1,658	\$1,846	\$2,279
		60" TO 71 1/2" w/Panel up to 24"		\$1,627	\$1,773	\$1,962	\$2,394

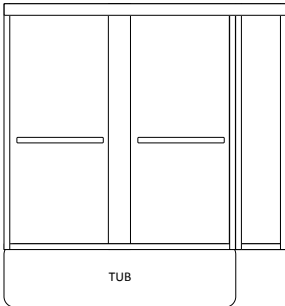

CTX-670- TALLER BYPASS TUB WITH PANEL SIZES W/ 1/4" GLASS							
	MODEL	MIN TO MAX WIDTH	HEIGHT	SILVER	GOLD	SATIN NICKEL	STANDARD PAINT
1/4" CLEAR	CTX-670	48" TO 59 1/2" w/Panel up to 12"	62 3/4"	\$1,344	\$1,490	\$1,679	\$2,111
		48" TO 59 1/2" w/Panel up to 18"		\$1,444	\$1,590	\$1,778	\$2,211
		48" TO 59 1/2" w/Panel up to 24"		\$1,561	\$1,707	\$1,896	\$2,328
		60" TO 71 1/2" w/Panel up to 12"		\$1,456	\$1,608	\$1,792	\$2,223
		60" TO 71 1/2" w/Panel up to 18"		\$1,556	\$1,702	\$1,891	\$2,323
		60" TO 71 1/2" w/Panel up to 24"		\$1,674	\$1,820	\$2,008	\$2,441
	CTXX-670	54" TO 59 1/2" w/Panel up to 12"	66"	\$1,370	\$1,518	\$1,707	\$2,050
		54" TO 59 1/2" w/Panel up to 18"		\$1,473	\$1,619	\$1,807	\$2,240
		54" TO 59 1/2" w/Panel up to 24"		\$1,591	\$1,737	\$1,926	\$2,358

Anodized aluminum may vary in shade and color among extrusions. Color variance is considered within factory tolerances in the Anodizing Industry.

Available in Standard Paint \* Buttruss available

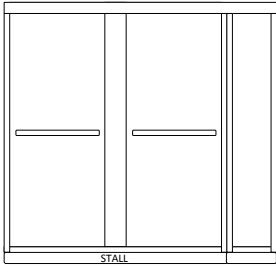

CS-1670- STALL BYPASS WITH PANEL W/ 1/4" GLASS							
	MODEL	MIN TO MAX WIDTH	HEIGHT	SILVER	GOLD	SATIN NICKEL	STANDARD PAINT
1/4" CLEAR	CS-1670	36" TO 47 1/2" w/Panel up to 12"	70 3/4"	\$1,366	\$1,495	\$1,665	\$2,077
		36" TO 47 1/2" w/Panel up to 18"		\$1,462	\$1,590	\$1,760	\$2,180
		36" TO 47 1/2" w/Panel up to 24"		\$1,559	\$1,687	\$1,869	\$2,301
		48" TO 59 1/2" w/Panel up to 12"		\$1,471	\$1,597	\$1,767	\$2,177
		48" TO 59 1/2" w/Panel up to 18"		\$1,566	\$1,694	\$1,864	\$2,247
		48" TO 59 1/2" w/Panel up to 24"		\$1,662	\$1,790	\$1,969	\$2,401
		60" TO 65 1/2" w/Panel up to 12"		\$1,522	\$1,651	\$1,821	\$2,237
		60" TO 65 1/2" w/Panel up to 18"		\$1,618	\$1,747	\$1,917	\$2,339
		60" TO 65 1/2" w/Panel up to 24"		\$1,715	\$1,841	\$2,029	\$2,460

Anodized aluminum may vary in shade and color among extrusions. Color variance is considered within factory tolerances in the Anodizing Industry.

Available in Standard Paint

\* Buttruss available

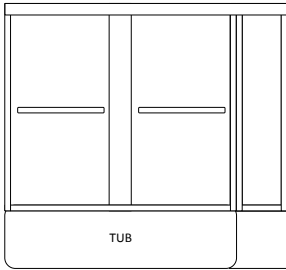

CT-670- BYPASS TUB WITH PANEL W/ 3/8" GLASS							
	MODEL	MIN TO MAX WIDTH	HEIGHT	SILVER	GOLD	SATIN NICKEL	STANDARD PAINT
3/8" CLEAR	CT-670	48" TO 59 1/2" w/Panel up to 12"	57 3/4"	\$1,729	\$1,875	\$2,064	\$2,496
		48" TO 59 1/2" w/Panel up to 18"		\$1,872	\$2,013	\$2,197	\$2,609
		48" TO 59 1/2" w/Panel up to 24"		\$1,960	\$2,101	\$2,285	\$2,697
		60" TO 71 1/2" w/Panel up to 12"		\$1,867	\$2,013	\$2,201	\$2,634
		60" TO 71 1/2" w/Panel up to 18"		\$2,047	\$2,194	\$2,383	\$2,815
		60" TO 71 1/2" w/Panel up to 24"		\$2,197	\$2,333	\$2,518	\$2,932

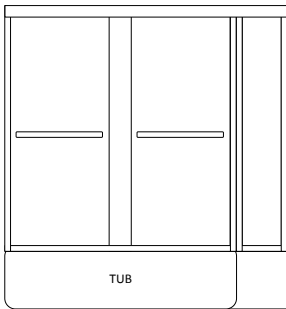

CTX-670- TALLER BYPASS TUB WITH PANEL SIZES W/ 3/8" GLASS							
	MODEL	MIN TO MAX WIDTH	HEIGHT	SILVER	GOLD	SATIN NICKEL	STANDARD PAINT
3/8" CLEAR	CTX-670	48" TO 59 1/2" w/Panel up to 12"	62 3/4"	\$1,970	\$1,925	\$2,113	\$2,546
		48" TO 59 1/2" w/Panel up to 18"		\$1,963	\$2,109	\$2,299	\$2,730
		48" TO 59 1/2" w/Panel up to 24"		\$2,124	\$2,264	\$2,448	\$2,861
		60" TO 71 1/2" w/Panel up to 12"		\$2,014	\$2,142	\$2,312	\$2,694
		60" TO 71 1/2" w/Panel up to 18"		\$2,111	\$2,258	\$2,447	\$2,879
		60" TO 71 1/2" w/Panel up to 24"		\$2,273	\$2,419	\$2,607	\$3,040
	CTXX-670	54" TO 59 1/2" w/Panel up to 12"	66"	\$1,837	\$1,967	\$2,156	\$2,588
		54" TO 59 1/2" w/Panel up to 18"		\$2,007	\$2,154	\$2,342	\$2,775
		54" TO 59 1/2" w/Panel up to 24"		\$2,169	\$2,315	\$2,505	\$2,918

Anodized aluminum may vary in shade and color among extrusions.  
Color variance is considered within factory tolerances in the Anodizing Industry.

Available in Standard Paint \* Butress available

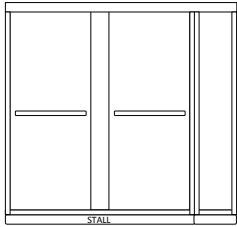

CS-1670- STALL BYPASS WITH PANEL W/ 3/8" GLASS							
	MODEL	MIN TO MAX WIDTH	HEIGHT	SILVER	GOLD	SATIN NICKEL	STANDARD PAINT
3/8" CLEAR	CS-1670	36" TO 47 1/2" w/Panel up to 12"	70 3/4"	\$1,893	\$2,020	\$2,190	\$2,568
		36" TO 47 1/2" w/Panel up to 18"		\$2,005	\$2,131	\$2,301	\$2,679
		36" TO 47 1/2" w/Panel up to 24"		\$2,099	\$2,223	\$2,393	\$2,773
		48" TO 59 1/2" w/Panel up to 12"		\$2,060	\$2,187	\$2,355	\$2,734
		48" TO 59 1/2" w/Panel up to 18"		\$2,167	\$2,294	\$2,462	\$2,841
		48" TO 59 1/2" w/Panel up to 24"		\$2,274	\$2,399	\$2,568	\$2,949
		60" TO 65 1/2" w/Panel up to 12"		\$2,205	\$2,332	\$2,502	\$2,880
		60" TO 65 1/2" w/Panel up to 18"		\$2,312	\$2,438	\$2,608	\$2,986
		60" TO 65 1/2" w/Panel up to 24"		\$2,418	\$2,545	\$2,715	\$3,093

Shaded models indicate that a strengthened header will be used due to excessive weight. This adds 3/8" to Height.

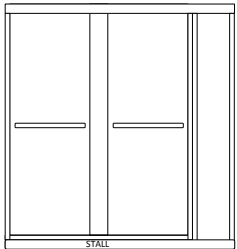

CSX-1670- TALLER STALL BYPASS WITH PANEL W/ 3/8" GLASS							
	MODEL	MIN TO MAX WIDTH	HEIGHT	SILVER	GOLD	SATIN NICKEL	STANDARD PAINT
3/8" CLEAR	CSX-1670	36" TO 47 1/2" w/Panel up to 12"	76"	\$1,906	\$2,044	\$2,229	\$2,642
		36" TO 47 1/2" w/Panel up to 18"		\$2,012	\$2,148	\$2,332	\$2,746
		36" TO 47 1/2" w/Panel up to 24"		\$2,037	\$2,183	\$2,372	\$2,804
		48" TO 59 1/2" w/Panel up to 12"		\$2,078	\$2,178	\$2,398	\$2,815
		48" TO 59 1/2" w/Panel up to 18"		\$2,182	\$2,320	\$2,505	\$2,918
		48" TO 59 1/2" w/Panel up to 24"		\$2,287	\$2,424	\$2,608	\$3,022
		60" TO 65 1/2" w/Panel up to 12"		\$2,226	\$2,365	\$2,446	\$2,962
		60" TO 65 1/2" w/Panel up to 18"		\$2,330	\$2,467	\$2,653	\$3,065
		60" TO 65 1/2" w/Panel up to 24"		\$2,433	\$2,571	\$2,755	\$3,169

Shaded models indicate that a strengthened header will be used due to excessive weight. This adds 3/8" to Height.

Anodized aluminum may vary in shade and color among extrusions. Color variance is considered within factory tolerances in the Anodizing Industry.

Available in Standard Paint

\* Buttruss available

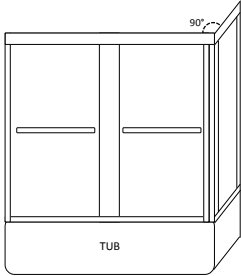

CT-636-BYPASS TUB WITH 90° RETURN PANEL W/ 1/4" GLASS							
	MODEL	MIN TO MAX WIDTH	HEIGHT	SILVER	GOLD	SATIN NICKEL	STANDARD PAINT
1/4" CLEAR	CT-636	Slider 48" TO 59 1/2" return up to 30"	57 3/4"	\$1,689	\$1,827	\$2,012	\$2,424
		Slider 48" TO 59 1/2" return up to 36"		\$1,806	\$1,944	\$2,128	\$2,542
		Slider 60" TO 71 1/2" return up to 30"		\$1,804	\$1,942	\$2,125	\$2,540
		Slider 60" TO 71 1/2" return up to 36"		\$1,922	\$2,059	\$2,243	\$2,657

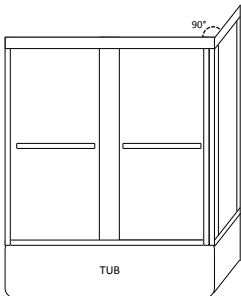

CTX-636-TALLER BYPASS TUB WITH 90° RETURN PANEL W/ 1/4" GLASS							
	MODEL	MIN TO MAX WIDTH	HEIGHT	SILVER	GOLD	SATIN NICKEL	STANDARD PAINT
1/4" CLEAR	CTX-636	Slider 48" TO 59 1/2" return up to 30"	62 3/4"	\$1,777	\$1,913	\$2,098	\$2,512
		Slider 48" TO 59 1/2" return up to 36"		\$1,898	\$2,037	\$2,220	\$2,634
		Slider 60" TO 71 1/2" return up to 30"		\$1,894	\$2,031	\$2,215	\$2,630
		Slider 60" TO 71 1/2" return up to 36"		\$2,016	\$2,155	\$2,338	\$2,753
	CTXX-636	Slider 54" TO 59 1/2" return up to 30"	66"	\$1,817	\$1,956	\$2,141	\$2,552
		Slider 54" TO 59 1/2" return up to 36"		\$1,943	\$2,081	\$2,265	\$2,678

Anodized aluminum may vary in shade and color among extrusions. Color variance is considered within factory tolerances in the Anodizing Industry.



Available in Standard Paint \* Buttruss available

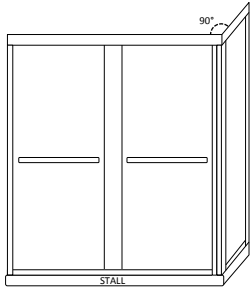

CS-1648-STALL BYPASS WITH 90° RETURN PANEL W/ 1/4" GLASS							
	MODEL	MIN TO MAX WIDTH	HEIGHT	SILVER	GOLD	SATIN NICKEL	STANDARD PAINT
1/4" CLEAR	CS-1648	Slider 36" TO 47 1/2" return up to 30"	70 3/4"	\$1,808	\$1,947	\$2,131	\$2,543
		Slider 36" TO 47 1/2" return up to 36"		\$1,895	\$2,033	\$2,217	\$2,631
		Slider 48" TO 59 1/2" return up to 30"		\$1,946	\$2,092	\$2,281	\$2,703
		Slider 48" TO 59 1/2" return up to 36"		\$2,057	\$2,194	\$2,378	\$2,790
		Slider 60" TO 65 1/2" return up to 30"		\$2,006	\$2,200	\$2,340	\$2,773
		Slider 60" TO 65 1/2" return up to 36"		\$2,124	\$2,270	\$2,459	\$2,885

Anodized aluminum may vary in shade and color among extrusions.  
Color variance is considered within factory tolerances in the Anodizing Industry.

Available in Standard Paint

\* Buttruss available

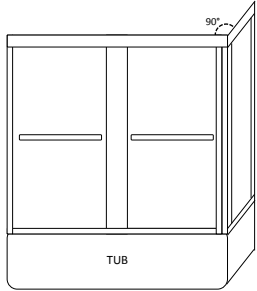

CT-636 BYPASS TUB WITH 90° RETURN PANEL W/ 3/8" GLASS							
	MODEL	MIN TO MAX WIDTH	HEIGHT	SILVER	GOLD	SATIN NICKEL	STANDARD PAINT
3/8" CLEAR	CT-636	Slider 48" TO 59 1/2" return up to 30"	57 3/4"	\$2,074	\$2,212	\$2,395	\$2,809
		Slider 48" TO 59 1/2" return up to 36"		\$2,194	\$2,332	\$2,516	\$2,931
		Slider 60" TO 71 1/2" return up to 30"		\$2,325	\$2,462	\$2,645	\$3,062
		Slider 60" TO 71 1/2" return up to 36"		\$2,451	\$2,588	\$2,773	\$3,186

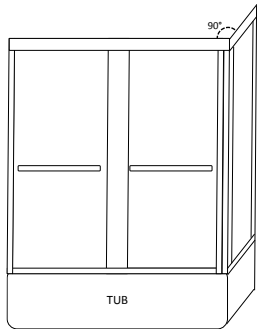

CTX-636- TALLER BYPASS TUB WITH 90° RETURN PANEL W/ 3/8" GLASS							
	MODEL	MIN TO MAX WIDTH	HEIGHT	SILVER	GOLD	SATIN NICKEL	STANDARD PAINT
3/8" CLEAR	CTX-636	Slider 48" TO 59 1/2" return up to 30"	62 3/4"	\$2,194	\$2,332	\$2,516	\$2,931
		Slider 48" TO 59 1/2" return up to 36"		\$2,320	\$2,457	\$2,692	\$3,055
		Slider 60" TO 71 1/2" return up to 30"		\$2,448	\$2,584	\$2,768	\$3,183
		Slider 60" TO 71 1/2" return up to 36"		\$2,578	\$2,716	\$2,899	\$3,313
	CTXX-636	Slider 54" TO 59 1/2" return up to 30"	66"	\$2,251	\$2,390	\$2,572	\$2,986
		Slider 54" TO 59 1/2" return up to 36"		\$2,381	\$2,518	\$2,700	\$3,116

☐ Shaded models indicate that a strengthened header will be used due to excessive weight. This adds 3/8" to Height.

Anodized aluminum may vary in shade and color among extrusions. Color variance is considered within factory tolerances in the Anodizing Industry.

Available in Standard Paint

\* Buttruss available

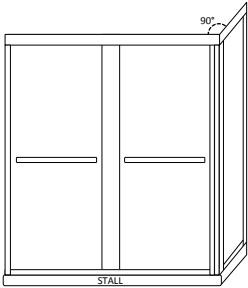

CS-1648- STALL BYPASS WITH 90° RETURN PANEL W/ 3/8" GLASS							
	MODEL	MIN TO MAX WIDTH	HEIGHT	SILVER	GOLD	SATIN NICKEL	STANDARD PAINT
3/8" CLEAR	CS-1648	Slider 36" TO 47 1/2" return up to 30"	70 3/4"	\$2,185	\$2,322	\$2,506	\$2,919
		Slider 36" TO 47 1/2" return up to 36"		\$2,320	\$2,457	\$2,642	\$3,055
		Slider 48" TO 59 1/2" return up to 30"		\$2,340	\$2,478	\$2,661	\$3,076
		Slider 48" TO 59 1/2" return up to 36"		\$2,477	\$2,613	\$2,799	\$3,213
		Slider 60" TO 65 1/2" return up to 30"		\$2,522	\$2,660	\$2,844	\$3,258
		Slider 60" TO 65 1/2" return up to 36"		\$2,664	\$2,801	\$2,985	\$3,398

Shaded models indicate that a strengthened header will be used due to excessive weight. This adds 3/8" to Height.

Anodized aluminum may vary in shade and color among extrusions.  
Color variance is considered within factory tolerances in the Anodizing Industry.

Available in Standard Paint

\* Buttruss available

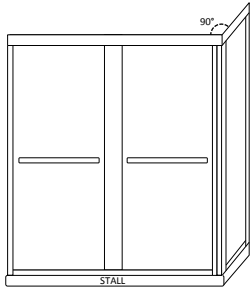

CSX-1648- TALLER STALL BYPASS WITH 90° RETURN PANEL W/ 3/8" GLASS							
	MODEL	MIN TO MAX WIDTH	HEIGHT	SILVER	GOLD	SATIN NICKEL	STANDARD PAINT
3/8" CLEAR	CSX-1648	Slider 36" TO 47 1/2" return up to 30"	76"	\$2,362	\$2,500	\$2,685	\$3,096
		Slider 36" TO 47 1/2" return up to 36"		\$2,506	\$2,643	\$2,828	\$3,241
		Slider 48" TO 59 1/2" return up to 30"		\$2,480	\$2,618	\$2,802	\$3,216
		Slider 48" TO 59 1/2" return up to 36"		\$2,625	\$2,762	\$2,948	\$3,361
		Slider 60" TO 65 1/2" return up to 30"		\$2,673	\$2,812	\$2,996	\$3,409
		Slider 60" TO 65 1/2" return up to 36"		\$2,821	\$2,961	\$3,146	\$3,558

Shaded models indicate that a strengthened header will be used due to excessive weight. This adds 3/8" to Height.

Anodized aluminum may vary in shade and color among extrusions.  
Color variance is considered within factory tolerances in the Anodizing Industry.

## SEMI-FRAMELESS PIVOT HINGE

### STANDARD FEATURES ON CENTEC HINGE

- Complete with reversible header allowing either round or flat profile.
- 6" C-Pull handle included in price
- 1/4" Clear tempered glass (1/4" stock Bubble glass is also available for many models/sizes—call for pricing)
- Built in aluminum drip pan with vinyl or a vinyl deflector
- 8" handles available, but require custom pricing. Please call for a quote.
- Custom sizes also available -- contact Century for pricing.
- Custom configurations are available for most CH units, including additional inline panels, buttress panels, angle cut panels or doors to follow the slope of the ceiling, etc. Please contact us for details.

**Available in Standard Paint**

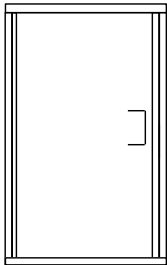

CH-70 SINGLE DOOR					
MODEL	MIN TO MAX WIDTH	HEIGHT	SILVER	SATIN NICKEL	STANDARD PAINT
CH-70-23 1/2	23 1/4" - 23 3/4"	72 3/4"	\$768	\$838	\$1,025
↓	↓				
CH-70-27	26 3/4" - 27 1/4"		\$774	\$875	\$1,029
CH-70-27 1/2	27 1/4" - 27 3/4"				
↓	↓				
CH-70-31	30 3/4" - 31 1/4"				

Standard Colors include: Pearl White, Oil Rubbed Bronze, Matte Black. Custom color matching is also available for most Centec models- please call for pricing.

Anodized aluminum may vary in shade and color among extrusions. Color variance is considered within factory tolerances in the Anodizing Industry.

Available in Standard Paint

\* Buttruss available

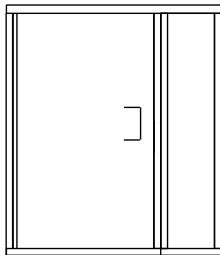

CH-1627 DOOR & PANEL					
MODEL	MIN TO MAX WIDTH	HEIGHT	SILVER	SATIN NICKEL	STANDARD PAINT
CH-1627-30	30-30 1/2"	72 3/4"	\$841	\$1021	\$1,275
↓	↓				
CH-1627-35 1/2	35 1/2- 36"				
CH-1627-36	36- 36 1/2"		\$870	\$1,068	\$1,322
↓	↓				
CH-1627-41 1/2	41 1/2- 42"				
CH-1627-42	42- 42 1/2"		\$917	\$1,116	\$1,370
↓	↓				
CH-1627-47 1/2	47 1/2- 48"				
CH-1627-48	48- 48 1/2"		\$966	\$1,163	\$1,419
↓	↓				
CH-1627-53 1/2	53 1/2- 54"				
CH-1627-54	54- 54 1/2"		\$1,041	\$1,239	\$1,494
↓	↓				
CH-1627-59 1/2	59 1/2- 60"				
CH-1627-MOD	30-36"	68 1/4"	\$830	\$1,029	\$1,284
	36-42"		\$917	\$1,116	\$1,370
	42-48"		\$1,002	\$1,202	\$1,456
	48-54"		\$1,091	\$1,289	\$1,544
	54-60"		\$1,202	\$1,399	\$1,655
	30-36"	65 3/4"	\$888	\$1,087	\$1,341
	36-42"		\$966	\$1,163	\$1,419
	42-48"		\$1,042	\$1,240	\$1,495
	48-54"		\$1,120	\$1,318	\$1,572
	54-60"		\$1,218	\$1,418	\$1,673

\* Module prices in Clear represent stock glass, Door & Panel sizes cannot be specified. Buttruss available on existing in-line panel, but requires custom glass- call for pricing

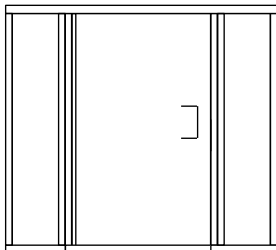

CH-1628- PANEL, DOOR, PANEL					
MODEL	MIN TO MAX WIDTH	HEIGHT	SILVER	SATIN NICKEL	STANDARD PAINT
CH-1628-36	36-36 1/2"	72 3/4"	\$1,022	\$1,311	\$1,694
↓	↓				
CH-1628-43 1/2	43 1/2-44"		\$1,113	\$1,378	\$1,760
CH-1628-44	44- 44 1/2"				
↓	↓		\$1,205	\$1,443	\$1,824
CH-1628-51 1/2	51 1/2- 52"				
CH-1628-52	52- 52 1/2"				
↓	↓				
CH-1628-59 1/2	59 1/2- 60"				

Anodized aluminum may vary in shade and color among extrusions. Color variance is considered within factory tolerances in the Anodizing Industry.

Available in Standard Paint \* Buttruss available

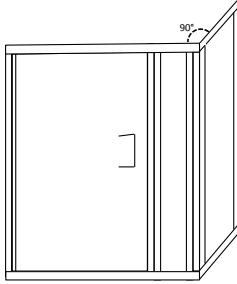

CH-1631- DOOR & PANEL WITH A 90° RETURN					
MODEL	MIN TO MAX WIDTH (centerline sizes up to)	HEIGHT	SILVER	SATIN NICKEL	STANDARD PAINT
CH-1631-1	34 1/2" X 34 1/2"	72 3/4"	\$1,581	\$1,778	\$2,318
CH-1631-2	40 1/2" X 34 1/2"		\$1,625	\$1,850	\$2,362
CH-1631-3	40 1/2" X 40 1/2"		\$1,723	\$1,981	\$2,459
CH-1631-4	48" X 36"		\$1,716	\$1,964	\$2,452
CH-1631-5	48" X 48"		\$1,910	\$2,166	\$2,632
CH-1631-6	54" X 36"		\$1,763	\$2,035	\$2,498
CH-1631-7	54" X 48"		\$1,956	\$2,237	\$2,690
CH-1631-8	60" X 36"		\$1,808	\$2,105	\$2,543
CH-1631-9	60" X 48"		\$2,001	\$2,308	\$2,738

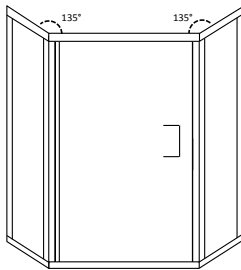

CH-1669- NEO-ANGLE PANEL, DOOR, PANEL					
MODEL	MIN TO MAX WIDTH (centerline dimensions)	HEIGHT	SILVER	SATIN NICKEL	STANDARD PAINT
CH-1669-1	16 1/2" x 24 1/4" x 16 1/2" (Fits 36"x 36" Base)	72 3/4"	\$1,247	\$1,499	\$2,014
CH-1669-2	16 1/2" x 25 1/4" x 16 1/2" (Fits 36"x 36" Base)				
CH-1669-3	17 1/2" x 24 1/4" x 17 1/2" (Fits 38"x 38" Base)				
CH-1669-4	18 1/2" x 24 1/4" x 18 1/2" (Fits 38"x 38" Base)				
CH-1669-NS1	Centerline up to 18 1/2" x 24 1/4" x 18 1/2"	65 5/8"	\$1,592	\$1,802	\$2,329
CH-1669-NS2	Centerline up to 22 1/2" x 26 1/4" x 22 1/2"		\$1,745	\$2,007	\$2,479
CH-1669-NS3	Centerline up to 30 1/2" x 28 1/4" x 30 1/2"		\$2,028	\$2,352	\$2,763
CH-1669 2/3	2/3 of a 135° Neo Angle Centerline up to 30" x 28"		\$1,595	\$1,845	\$2,332
CH-1669-LA	17 1/2" x 22 1/2" x 17 1/2" (Fits Lasco 1382 NAC)	70 3/8"	\$1,248	\$1,545	\$1,926
CH-1669-LA2P	17 1/2" x 23 7/8" x 17 1/2" (Fits Lasco 1382 NAC 2 Piece)		\$1,248	\$1,545	\$1,926
CH-1669-AK	15 1/2" x 27 1/2" x 15 1/2" (Fits Aker Neo)	70 3/8"	\$1,248	\$1,545	\$1,982
CH-1669-KO	15 1/2" x 26 1/2" x 15 1/2" (Fits Kohler Neo)		\$1,248	\$1,545	\$1,981
CH-1669-AG	18 3/4" x 23 1/4" x 18 3/4" (Fits Aqua Glass Neo Angle)		\$1,248	\$1,545	\$1,979

Anodized aluminum may vary in shade and color among extrusions.  
Color variance is considered within factory tolerances in the Anodizing Industry.

**SEMI-FRAMELESS CROSSOVER HINGE**

**STANDARD FEATURES ON CENTEC CROSSOVER HINGE**

- Complete with reversible header allowing either round or flat profile.
- 6" C-Pull handle included in price
- Aluminum patch hinges
- Custom configurations are available for most CHX units, including additional inline panels, buttress panels, angle cut panels or doors to follow the slope of the ceiling, etc. Please contact us for details.
- 1/4" Clear Tempered Glass
- Vinyl Deflector

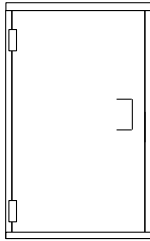

CHX-70 SINGLE DOOR				
MODEL	MIN TO MAX WIDTH (Centerline sizes up to)	HEIGHT	SILVER	SATIN NICKEL
CHX-70-23 1/4	23"- 23 1/2"	72 3/4"--- Available without header 70 7/8"	\$852	\$959
↓	↓			
CHX-70-26 3/4	26 1/2"- 27"			
CHX-70-27 1/4	27"- 27 1/2"			
↓	↓			
CHX-70-31 1/4	31"- 31 1/2"	\$909	\$1,016	

\* Buttress available

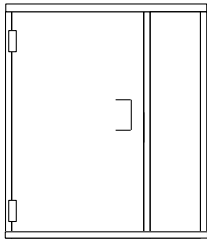

CHX-1627- DOOR & PANEL				
MODEL	MIN TO MAX WIDTH	HEIGHT	SILVER	SATIN NICKEL
CHX-1627-30	30-30 1/2"	72 3/4"	\$939	\$1,154
↓	↓			
CHX-1627-35 1/2	35 1/2- 36"			
CHX-1627-36	36- 36 1/2"			
↓	↓			
CHX-1627-41 1/2	41 1/2- 42"			
CHX-1627-42	42- 42 1/2"			
↓	↓			
CHX-1627-47 1/2	47 1/2- 48"			
CHX-1627-48	48- 48 1/2"			
↓	↓			
CHX-1627-53 1/2	53 1/2- 54"	\$1,085	\$1,301	
CHX-1627-54	54- 54 1/2"			
↓	↓			
CHX-1627-59 1/2	59 1/2- 60"	\$1,154	\$1,369	
CHX-1627-MOD	30-36"	68 1/4"	\$1,237	\$1,450
	36-42"		\$979	\$1,194
	42-48"		\$1,076	\$1,290
	48-54"		\$1,173	\$1,388
	54-60"		\$1,269	\$1,484
	30-36"	65 3/4"	\$1,390	\$1,604
	36-42"		\$1,061	\$1,178
	42-48"		\$1,132	\$1,289
	48-54"		\$1,207	\$1,398
	54-60"		\$1,281	\$1,497
		\$1,355	\$1,569	

Anodized aluminum may vary in shade and color among extrusions. Color variance is considered within factory tolerances in the Anodizing Industry.



\* Buttress available

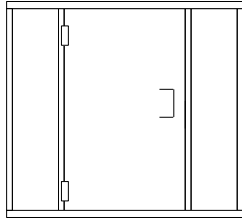

CHX-1628- DOOR, PANEL, DOOR				
MODEL	MIN TO MAX WIDTH	HEIGHT	SILVER	SATIN NICKEL
CHX-1628-36	36-36 1/2"	72 3/4"	\$1,104	\$1,426
↓	↓			
CHX-1628-43 1/2	43 1/2-44"			
CHX-1628-44	44- 44 1/2"			
↓	↓			
CHX-1628-51 1/2	51 1/2- 52"			
CHX-1628-52	52- 52 1/2"	\$1,164	\$1,487	
↓	↓			
CHX-1628-59 1/2	59 1/2- 60"	\$1,224	\$1,545	

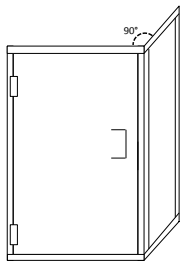

CHX-1630- DOOR WITH A 90° RETURN				
MODEL	MIN TO MAX WIDTH	HEIGHT	SILVER	SATIN NICKEL
CHX-1630-1	30" X 34 1/2"	72 3/4"	\$1,579	\$1,794
CHX-1630-2	30" X 36"		\$1,609	\$1,825
CHX-1630-3	30" X 40"		\$1,674	\$1,888
CHX-1630-4	30" X 48"		\$1,801	\$2,015

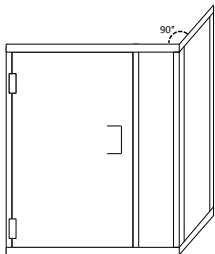

CHX-1631- DOOR & PANEL WITH A 90° RETURN				
MODEL	MIN TO MAX WIDTH (centerline up to)	HEIGHT	SILVER	SATIN NICKEL
CHX-1631-1	34 1/2" X 34 1/2"	72 3/4"	\$1,668	\$1,990
CHX-1631-2	40 1/2" X 34 1/2"		\$1,716	\$2,039
CHX-1631-3	40 1/2" X 40 1/2"		\$1,813	\$2,135
CHX-1631-4	48" X 36"		\$1,811	\$2,133
CHX-1631-5	48" X 48"		\$1,970	\$2,290
CHX-1631-6	54" X 36"		\$1,821	\$2,143
CHX-1631-7	54" X 48"		\$2,015	\$2,335
CHX-1631-8	60" X 36"		\$1,868	\$2,189
CHX-1631-9	60" X 48"		\$2,061	\$2,384

Anodized aluminum may vary in shade and color among extrusions. Color variance is considered within factory tolerances in the Anodizing Industry.

\* **Buttress available**

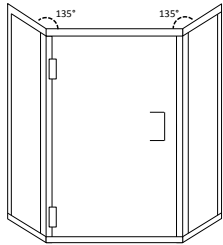

<b>CHX-1669- DOOR, PANEL, DOOR NEO-ANGLE</b>						
MODEL	MIN TO MAX WIDTH (centerline dimensions)	HEIGHT	SILVER	SATIN NICKEL		
CHX-1669-1	16 1/2" x 24 1/4" x 16 1/2" (Fits 36"x 36" Base)	72 3/4"	\$1,276	\$1,499		
CHX-1669-2	16 1/2" x 25 1/4" x 16 1/2" (Fits 36"x 36" Base)					
CHX-1669-3	17 1/2" x 24 1/4" x 17 1/2" (Fits 38"x 38" Base)					
CHX-1669-4	18 1/2" x 24 1/4" x 18 1/2" (Fits 38"x 38" Base)					
CHX-1669-NS1	Centerline up to 18 1/2" x 24 1/4" x 18 1/2"				\$1,518	\$1,771
CHX-1669-NS2	Centerline up to 22 1/2" x 26 1/4" x 22 1/2"				\$1,653	\$1,899
CHX-1669-NS3	Centerline up to 30 1/2" x 28 1/4" x 30 1/2"				\$1,920	\$2,159
CHX-1669 2/3	Two Thirds of a 135° Neo Angle up to 30" x 28"				\$1,541	\$1,791
CHX-1669-LA	17 1/2" x 22 1/2" x 17 1/2" (Fits Lasco 1382 NAC)	65 5/8"	\$1,549	\$1,826		
CHX-1669-LA2P	17 1/2" x 23 7/8" x 17 1/2" (Fits Lasco 1382 NAC 2 Piece)					
CHX-1669-AK	15 1/2" x 27 1/2" x 15 1/2" (Fits Aker Neo)	70 3/8"	\$1,549	\$1,826		
CHX-1669-KO	15 1/2" x 26 1/2" x 15 1/2" (Fits Kohler Neo)					
CHX-1669-AG	18 3/4" x 23 1/4" x 18 3/4" (Fits Aqua Glass Neo Angle)					

Anodized aluminum may vary in shade and color among extrusions.  
Color variance is considered within factory tolerances in the Anodizing Industry.

**AVAILABLE UPGRADES FOR 1/4" GLASS**

Glass Patterns/Tints	Sq.Ft. List Price
Low Iron	\$41
Niagara (Rain)	\$46
Stipolite (Pattern 62)	\$46
Satin Etch	\$55
Starphire	\$41
Reed	\$79
Clear	\$25
Bubble	\$96

**AVAILABLE UPGRADES FOR 3/8" GLASS**

Glass Patterns/Tints	Sq.Ft. List Price
Low Iron	\$66
Niagara (Rain)	\$82
Stipolite (Pattern 62)	\$77
Satin Etch	\$88
Starphire	\$66
Satin Etch LI	\$115
ShowerGuard LI	\$111
Clear	\$41

\* Please call to check availability of ALL glass upgrades.

Prices shown are per square foot and are incremental to clear glass price, so can be added to the unit list price.

Formula for Square Feet:

Door Width (inches) X Door Height (inches) ÷ 144 = SF

Example: 28" x 80" = 2240 ÷ 144 = 15.55 SF (Round to whole number)

	<b>\$/ Sq Ft</b>
Diamon Fusion	\$10

Diamon Fusion is a one-time, chemical treatment that is applied to and absorbed by the glass in order to add a layer of protection to the glass, reducing the required cleaning time.

(APPLIED TO BOTH SIDES OF THE GLASS)



1/4 bubble

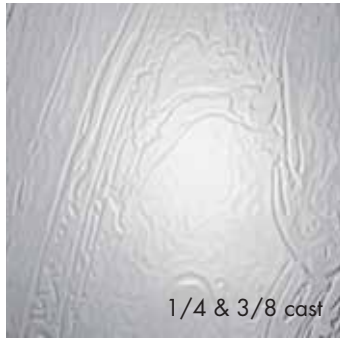

1/4 & 3/8 cast



3/8 satin etch coral



1/4 & 3/8 glue chip



3/8 satin etch ice

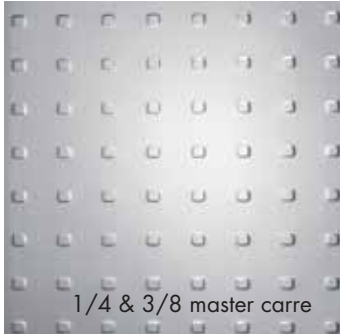

1/4 & 3/8 master carre

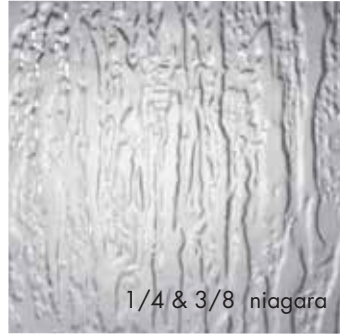

1/4 & 3/8 niagara



1/4 spraylite



1/4 & 3/8 reeded



1/4 & 3/8 stipolite  
(Pattern 62)



DIAMON-FUSION INTERNATIONAL  
"Innovation That Ignites Business"

The optional Diamon-Fusion treatment helps protect the glass from the build up of soap scum and hard water deposits and reduces cleaning time by 50%. Applied to both sides of the glass, a vapor mist fills the natural microscopic peaks and valleys in the glass with an ultra thin optically clear durable material making it easier to clean. Simply wipe down with a washcloth or squeegee after showering.



Customers ask for ShowerGuard glass by name because it's the first and best permanent protective shower glass on the market. Wipe-on, spray-on alternatives may need to be periodically re-applied after use. ShowerGuard is applied to one side of the glass during the manufacturing process. Only ShowerGuard has a lifetime limited warranty.

Available in Standard Paint









<b>AVAILABLE HANDLES FOR HINGED MODELS</b> (prices shown assume a set of 2 back to back handles)			
<b>DESCRIPTION</b>	<b>6"</b>	<b>8"</b>	<b>Samples</b>
<b>C-Pull</b>	\$68	\$204	
<b>Spindle</b>	\$218	\$255	
<b>Bow</b>	\$212	\$238	
<b>Circle</b>	\$255	N/A	
<b>Highline Flat</b>	\$280	\$336	
<b>Square (Taiga)</b>	\$206	\$184	
<b>Ladder</b>	\$145	\$190	
<b>Coda</b>	\$233	\$203	
<b>Symphony</b>	\$358	\$352	
<b>Aria</b>	\$556	\$595	
<b>Concerto</b>	\$358	\$440	

\* Additional handle styles available (including 8" handles)- please contact us for more details and pricing

\* Clamp On Handle Available for No Additional Charge

Anodized aluminum may vary in shade and color among extrusions.  
Color variance is considered within factory tolerances in the Anodizing Industry.

Available in Standard Paint

AVAILABLE TOWEL BARS FOR SLIDER MODELS (BARS AVAILABLE IN 15", 18", 21", 24", 27" & 30" LENGTHS, EXCEPT WHERE OTHERWISE NOTED)		
DESCRIPTION	SET OF 2 SINGLE-SIDED TOWEL BARS	SAMPLES
Modern	\$127	
Traditional	\$242	
Spindle	\$487	
Bow (18" & 24" only)	\$372	
Square (Taiga, 18" & 24" only)	\$414	
Aria (24" only)	\$462	
Coda (18" & 24" only)	\$375	
Symphony (24" & 30" only)	\$566	
Concerto (24" & 30" only)	\$566	

Anodized aluminum may vary in shade and color among extrusions. Color variance is considered within factory tolerances in the Anodizing Industry.

Additional towel bars are available, including back to back towel bars for hinged models. Please call for pricing.

Available in Standard Paint

AVAILABLE FINISHES	DESCRIPTION	PRICE
<b>Silver Anodized Aluminum</b>	Bright, chrome-like finish	Standard for all Centec models, except Select and Premier units
<b>Gold Anodized Aluminum</b> (Available for Slider)	This finish will vary in shade and color among extrusions, but is within the tolerances established by the anodizing industry.	\$44 per panel
<b>Satin Nickel Anodized Aluminum</b> (Available for Slider, CH, and CHX Models)	This finish will vary in shade and color among extrusions, but is within the tolerances established by the anodizing industry.	\$102 per panel
<b>Standard Paint (Available for Slider and CH Models)</b>	Standard Colors for a baked enamel painted finish: Pearl White, Matte Black, Oil Rubbed Bronze.	\$234 per panel
<b>Custom Color Matching (Available for Slider and CH Models)</b>	Custom Color Matching can be obtained by submitting a tile, fabric, or paint sample. If the samples are muddled or marbelized, you must pick a solid color within the sample to match; variations cannot be matched.	\$234 per panel + \$512 setup

Anodized aluminum may vary in shade and color among extrusions. Color variance is considered within factory tolerances in the Anodizing Industry.

Available in Standard Paint

DESCRIPTION	PRICE (TO BE ADDED TO LIST)
<b>Buttress (on existing panels)</b> (Charge to convert full height panel to buttress panel)	Slider in-line or return panels: \$89 added to list price
	Hinged unit return panels: \$89 added to list price
	Hinge unit in-line panels: \$12 per sq ft (Clear) (multiplied by sq footage of buttress panel)
<b>Notched Panel (for enclosures w/ a buttress(es))</b>	1/4" 2 sq ft or under (24x12):\$240, <i>plus custom glass</i>
	1/4" Over 2 sq ft (24x12):\$286, <i>plus custom glass</i>
	3/8" 2 sq ft or under (24x12):\$379, <i>plus custom glass</i>
	3/8" Over 2 sq ft (24x12):\$453, <i>plus custom glass</i>
<b>Frameless Mitered Corner</b> (Glass with a 45° miter joining at the corner; no metal corner post) <b>**Notched Panel is required- min 2 1/2" cline**</b>	\$255 per corner added, <i>plus custom glass</i>
<b>Special Angles, other than 135° Neo Angle Unit (1669):</b>	\$255 added to unit list price
<b>Angle Ceiling Enclosure</b> (glass cut to follow slope of the ceiling)	1/4": \$328, <i>plus custom glass</i>
	3/8": \$453, <i>plus custom glass</i>
<b>Crown Molding Header</b>	Hinged Doors: \$9 per ft
	Bypass Doors: \$11 per ft
<b>Additional Inline/ Buttress Inline Panels</b>	Up to 12": \$379 for Clear
	Up to 24": \$497 for Clear
<b>Angle Mount (units hitting a wall at an angle other than 90°; various configurations available based on application)</b>	Mounting to a 135° angled wall- add \$110 per mount
	Mounting to an angled wall other than 90° or 149° add \$255 per mount
<b>Special Width (for units wider than those specified in the price lists)</b>	\$110 per 6" over std width, <i>plus custom glass</i>
<b>Special Height (for units taller than those specified in the price lists)</b>	\$110 per 6" over std height, per panel, <i>plus custom glass</i>
<b>Cutdown (for units shorter than those specified in the price lists)</b>	\$73 per panel <i>plus custom glass</i>

Anodized aluminum may vary in shade and color among extrusions.  
 Color variance is considered within factory tolerances in the Anodizing Industry.



Available in Standard Paint

	DESCRIPTION	PRICE
<b>Straight Fillers</b> <b>(Slider or Hinged Models)</b>	Up to 1/2" filler to the wall or base	Add \$52 to list price, per jamb
	Up to 1" filler to the wall or base	Add \$65 to list price, per jamb
<b>Tapered Fillers</b> <b>(Slider or Hinged Models)</b>	Custom made filler cut per customer specification for out of plumb or out of level conditions	0-1" - Add \$101 to list price, per filler
		1-2" - Add \$198 to list price, per filler
		Over 2" - contact Century for a quote.

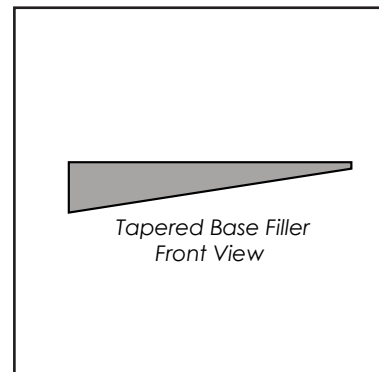
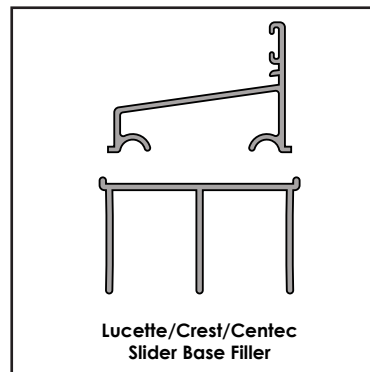
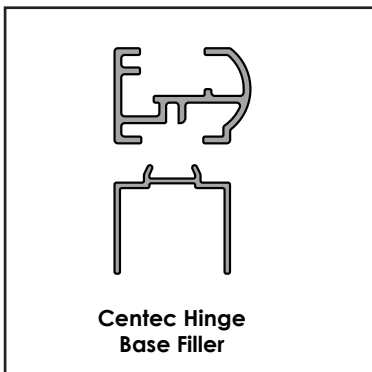
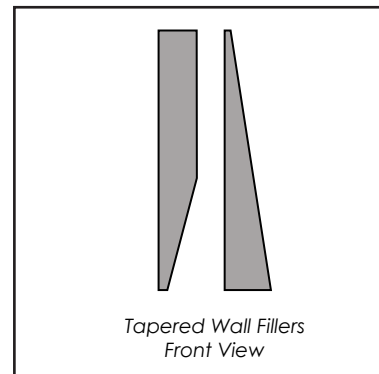
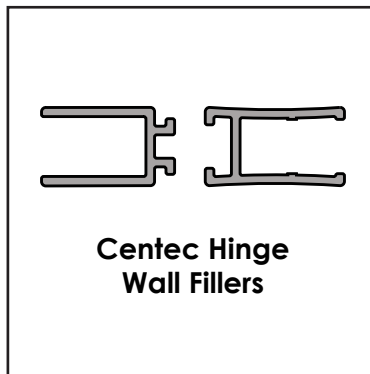
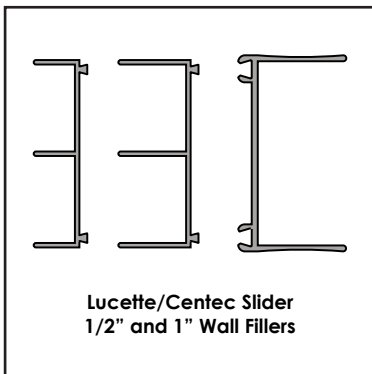

Anodized aluminum may vary in shade and color among extrusions.  
Color variance is considered within factory tolerances in the Anodizing Industry.